

CONTEXT

Werbemanufaktur

**macht
Emotionen
sichtbar**

Product Index

● Pop-Ups

Impress Straight	12
Impress Options	14
Fabric	18
Fabric Premium	20
Magnetic	22
Magnetic Options	24
Tower	26

● Zipper-Walls

Curved	30
Straight	32
Arch	34
Moon	36
Banner	38
Sizes	40

● Roll-Banners

Selection table	46
Cube	48
Budget	50
Challenger	52
Basic	54
Plus	56
Triangle	58
Evolution	60
Delight	62
Premium	64
Massive	66
Deluxe	68
Twin	70
Double	72
Extreme	74
Mini	76

● Banner Stands

L-Banner Quick	80
L-Banner Telescopic	82
X-Banner Budget	84
X-Banner Premium	86

● Lighting

Banner LED	90
Banner Light Halogen 35	92
Banner Light Halogen 50	93
Wall LED 50	94
Wall LED 116	96
Wall Light Halogen	98
Luxurious Light Bag	100
Wall Light Options	101

● Counters

Promotional	104
Professional Original M	106
Professional Original L	106
Professional Square	108
Professional Round	108
Magnetic	110
Fabric	112
Flex Counter	114

● Information Systems

Flex Tower	118
Brochure Holder Magnetic	120
Brochure Holder Budget	122
Brochure Holder Easy	124
Brochure Holder ZigZag	126
Brochure Holder Deluxe	128
Poster Rail	130
Poster Frame	132
Poster Stand	134
Panel Base Aluminium	136

● Outdoor

Streetboard	140
Outdoor Banner	142

● Flags

Beach Flag Alu Wind	146
Beach Flag Alu Drop	148
Beach Flag Alu Square	150
Beach Flag Fiber Wind/Drop	152
Beach Flag Base	154
Promo Flag Wind/Drop	158
Flagpole 415	160
Flagpole 540	162

● Cases

Hard Case	166
Trolley Case	167
Transport Trolley	168
Soft Trolley	169

Lightbox

The Brightbox

12

4

5 YEAR
WARRANTY
★★★★★

Lightbox

The Brightbox

- ✓ Lightweight aluminium frame
- ✓ Linkable magnetic sides
- ✓ Equipped with LED lighting for striking lightbox effect

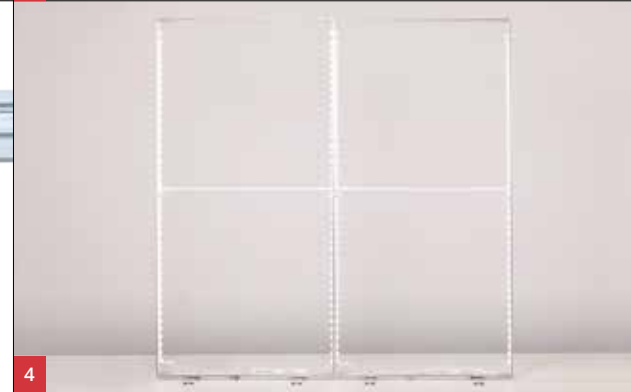

The Brightbox

EN

- Lightweight aluminium frame, equipped with powerful LED lighting on both sides
- Frame with grooved bars to hold Silicone Edge Graphics (1)
- Swing-out steel feet for optimum stability (2)
- Easy step-by-step installation thanks to pre-assembled LED lighting (3)
- Linkable thanks to powerful magnetic sides (4)
- Compact for storage and easy to transport in a portable, reinforced box (5)

DE

- Leichter Aluminiumrahmen mit leistungsstarker LED-Beleuchtung auf beiden Seiten
- Rahmen mit Rillen für Silicone Edge Graphics (1)
- Herausnehmbare Stahlfüße für optimale Stabilität (2)
- Einfach schrittweise zu montieren dank vormontierter LED-Beleuchtung (3)
- Verbindbar dank starker Magnetseiten (4)
- Kompakt zu lagern und einfach zu transportieren in einer tragbaren, verstärkten Box (5)

NL

- Lichtgewicht aluminium frame, voorzien van krachtige LED verlichting aan beide zijden
- Frame voorzien van groeven t.b.v. Silicone Edge Graphics (1)
- Uitdraaibare stalen voeten voor optimale stabiliteit (2)
- Eenvoudig stapsgewijs te monteren dankzij voormonteerde LED verlichting (3)
- Koppelbaar dankzij krachtige magnetische zijden (4)
- Compact op te bergen en eenvoudig te vervoeren in een draagbare, verstevigde box (5)

FR

- Cadre léger en aluminium, équipé d'un éclairage LED puissant des deux côtés
- Cadre doté de rainures pour les Silicone Edge Graphics (1)
- Pieds dévissables en acier pour une stabilité optimale (2)
- Montage facile en plusieurs étapes grâce à l'éclairage LED prémonté (3)
- Interconnectable grâce aux côtés magnétiques solides (4)
- Rangement compact et transport aisé dans une boîte portative renforcée (5)

ES

- Ligera estructura de aluminio con una potente iluminación LED a ambos lados
- Estructura provista de ranuras para los Silicone Edge Graphics (1)
- Pies de aluminio ajustables para una estabilidad óptima (2)
- Fácil de montar por pasos gracias a la iluminación LED ya instalada (3)
- Acoplable gracias a los potentes imanes en los laterales (4)
- Se guarda de un modo compacto y se transporta fácilmente en una caja portátil reforzada (5)

Product specifications

Art. nr.
BBOX100-200.B
All sizes in cm.

Dimensions

W	H	D
100	200	37,5

Package specifications

Outer box

PCS	W	H	D	KG
1	115	33	15	10

Pallet capacity

Euro	Industrial
31	42

No minimum order quantity



Instructional video

Pop-Ups

Impress Straight	12
Impress Options	14
Fabric	18
Fabric Premium	20
Magnetic	22
Magnetic Options	24
Tower	26

Pop-up Impress Straight

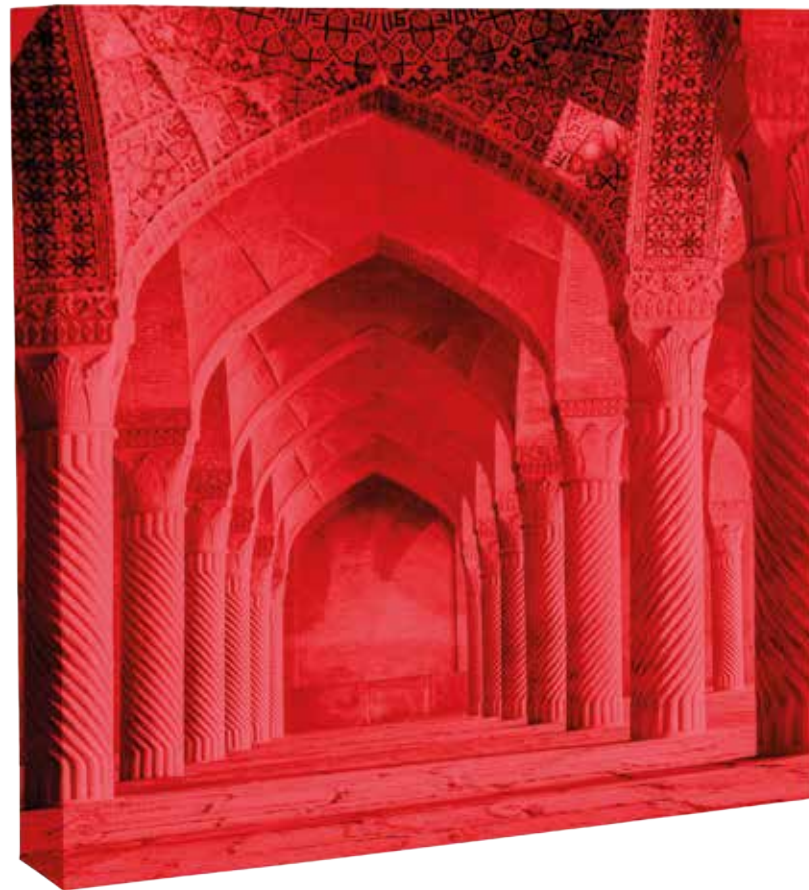

Pop-Up Impress Straight

EN

- White aluminium frame with grooved bars of 14 mm deep, that hold Silicone Edge Graphics (1)
- Equipped with fixation for lighting (2)
- Padded trolley with extra bag for storage bars (3)
- **Optional:** LED light curtains and accessories (4)
- **Optional:** LED or halogen lighting

DE

- Weißer Aluminiumrahmen mit gerillten Schienen von 14 mm tief, die Silicone Edge Graphics halten (1)
- Standardmäßig geliefert mit Befestigungssystem für die Beleuchtung (2)
- Gepolsterter Trolley mit separater Hülle zum Aufbewahren der Stäbe (3)
- **Optional:** LED-Lichtvorhänge und Zubehör (4)
- **Optional:** LED- oder Halogenbeleuchtung

NL

- Wit aluminium frame met gegroefde bars van 14 mm diep voor Silicone Edge Graphics (1)
- Standaard voorzien van bevestigingssysteem voor verlichting (2)
- Gevoerde trolley met losse hoes voor opbergen bars (3)
- **Optioneel:** LED lichtgordijnen en bijbehorende accessoires (4)
- **Optioneel:** LED of halogeenverlichting

FR

- Cadre aluminium blanc avec barres rainurées de 14 mm de profondeur pour Silicone Edge Graphics (1)
- Fourni avec système de fixation pour éclairage (2)
- Valise souple rembourée avec housse pour ranger les bars (3)
- **Optionnel :** Rideaux lumière LED avec accessoires (4)
- **Optionnel :** LED ou éclairage halogène

ES

- Estructura de aluminio blanca con barras acanaladas de 14 mm de profundidad para Silicone Edge Graphics (1)
- Equipado con punto de fijación para iluminación (2)
- Trolley acolchado con bolsa especial para guardar las barras (3)
- **Opcional:** Cortinas de luz LED y accesorios (4)
- **Opcional:** Iluminación LED o halógena

Attention: See next pages for options

Important: Available in 20 sizes

Width: Between 77 and 591 cm
Height: Between 224 and 371 cm

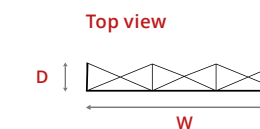

✓ Aluminium frame that holds Silicone Edge Graphics

✓ Equipable with LED-curtains for striking lightbox effect

✓ 20 impressive sizes, the biggest of its kind!



1

2



3



4: Optional, see next pages

Product specifications

Art. nr.	Frame	Dimensions		
		W	H	D
IMPR13S	1 x 3	77	224	36
IMPR23S	2 x 3	151	224	36
IMPR33S	3 x 3	224	224	36
IMPR43S	4 x 3	298	224	36
IMPR53S	5 x 3	371	224	36
IMPR63S	6 x 3	444	224	36
IMPR73S	7 x 3	517	224	36
IMPR83S	8 x 3	591	224	36
IMPR14S	1 x 4	77	298	36
IMPR24S	2 x 4	151	298	36
IMPR34S	3 x 4	224	298	36
IMPR44S	4 x 4	298	298	36
IMPR54S	5 x 4	371	298	36
IMPR64S	6 x 4	444	298	36
IMPR74S	7 x 4	517	298	36
IMPR84S	8 x 4	591	298	36
IMPR15S	1 x 5	77	371	36
IMPR25S	2 x 5	151	371	36
IMPR35S	3 x 5	224	371	36
IMPR45S	4 x 5	298	371	36

All sizes in cm.

Package specifications

Outer box					Pallet capacity	
PCS	W	H	D	KG	Euro	Industrial
1	35	94	25	11,5	18	24
1	35	94	25	13,6	18	24
1	35	94	31	16	12	18
1	35	94	31	18	12	18
1	41	94	35	21,3	10	12
1	41	94	35	23,2	10	12
1	35	94	31 *	26,9	9	12
1	41	94	35 *	30	8	10
1	35	94	25	13,5	18	24
1	35	94	25	16,1	18	24
1	35	94	31	19	12	18
1	35	94	31	21,3	12	18
1	41	94	35	24,8	10	12
1	35	94	31 *	12	9	12
1	35	94	31 *	12	9	12
1	41	94	35 *	12	8	10
1	37	94	25	15,5	18	24
1	37	94	25	18,5	18	24
1	41	94	35	22,3	12	18
1	41	94	35	25,3	10	12

* Separate box for bars

36 82 19

No minimum order quantity.



Instructional video

Pop-up

Impress Options



Feet

- EN** Easy attachable feet in 3 colours
(set of 2 pieces)
- DE** Einfach montierbare FüÙe in 3 Farben
(2 Stück)
- NL** Eenvoudig te monteren voeten in 3 kleuren
(set van 2)
- FR** Pieds en 3 couleurs simple à monter
(kit de 2 pièces)
- ES** Pies fáciles de montar y en 3 colores
(juego de 2 piezas)

! Important: A set of feet is recommended for more stability. Especially for frames of more than 4 levels high or 6 levels wide.

Art. nr.	Product
IMPR-FTWH	Pop-Up Impress Feet White
IMPR-FTS	Pop-Up Impress Feet Silver
IMPR-FTB	Pop-Up Impress Feet Black

3 levels high



4 levels high

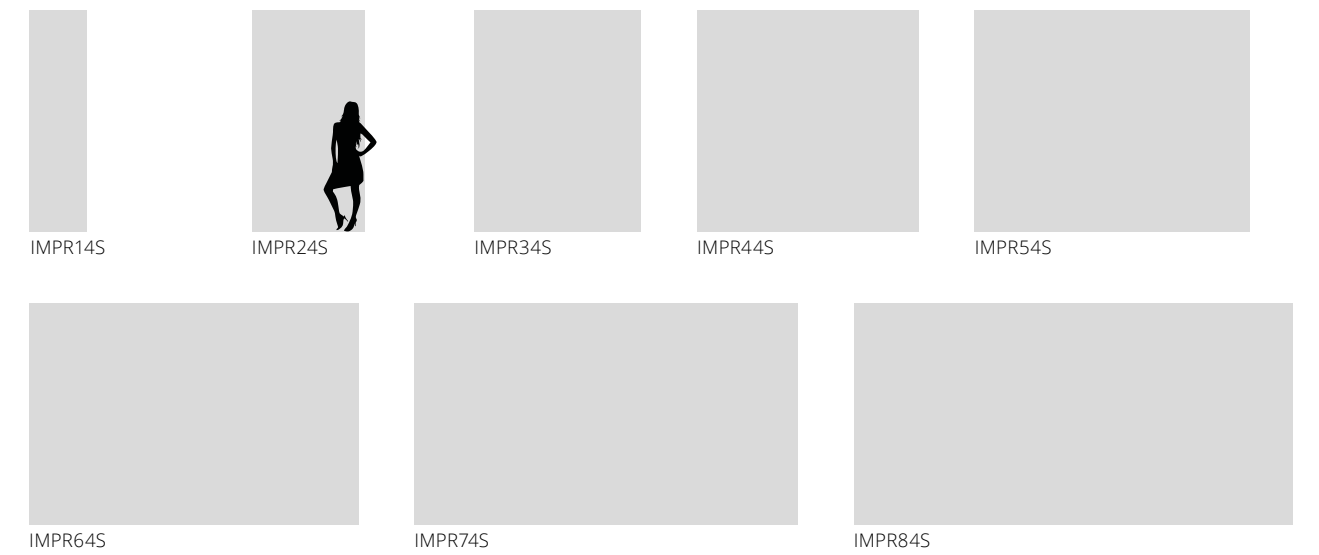

5 levels high

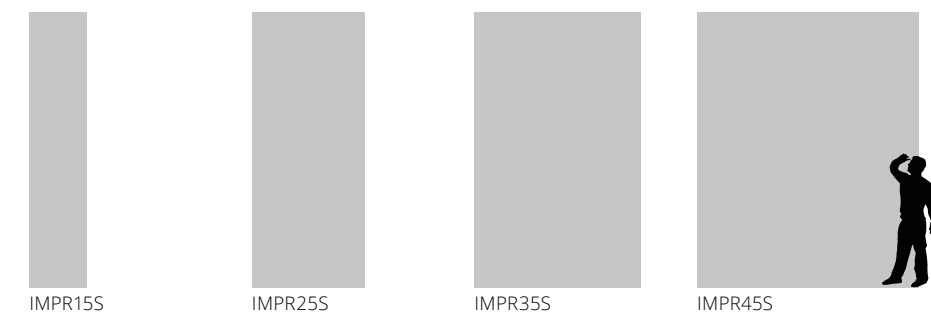

Sizes

Extra Bars for Backside

- EN** Extra bars to attach textile on backside frame (for top and bottom)
- DE** Extra Schienen um den Textil an der Rückseite zu befestigen (für Oberseite und Unterseite des Rahmens)
- NL** Extra bars om textiel aan achterkant te bevestigen (voor boven- en onderkant frame)
- FR** Barres additionnelles de fixation du textile au verso de la structure (pour le haut et le bas)
- ES** Barras adicionales para fijar el textil en la parte trasera de la estructura (parte superior e inferior)



3 levels high

Art. nr.	Product
IMPR13S-BARB	2 bars for backside
IMPR23S-BARB	4 bars for backside
IMPR33S-BARB	6 bars for backside
IMPR43S-BARB	8 bars for backside
IMPR53S-BARB	10 bars for backside
IMPR63S-BARB	12 bars for backside
IMPR73S-BARB	14 bars for backside
IMPR83S-BARB	16 bars for backside

4 levels high

Art. nr.	Product
IMPR14S-BARB	2 bars for backside
IMPR24S-BARB	4 bars for backside
IMPR34S-BARB	6 bars for backside
IMPR44S-BARB	8 bars for backside
IMPR54S-BARB	10 bars for backside
IMPR64S-BARB	12 bars for backside
IMPR74S-BARB	14 bars for backside
IMPR84S-BARB	16 bars for backside

5 levels high

Art. nr.	Product
IMPR15S-BARB	2 bars for backside
IMPR25S-BARB	4 bars for backside
IMPR35S-BARB	6 bars for backside
IMPR45S-BARB	8 bars for backside

Blockout Film Backside

- EN** Seamless blockout film for backside frame
- DE** Nahtlose lichtblockierende Blockout-Folie für Fensterrückseite
- NL** Naadloze block-out film voor achterzijde frame
- FR** Block-out film sans coutures pour verso du cadre
- ES** Película de bloqueo sin costuras para la parte posterior del cuadro



3 levels high

Art. nr.	Product
IMPR13S-BOB	Block-out Film 1 x 3
IMPR23S-BOB	Block-out Film 2 x 3
IMPR33S-BOB	Block-out Film 3 x 3
IMPR43S-BOB	Block-out Film 4 x 3
IMPR53S-BOB	Block-out Film 5 x 3
IMPR63S-BOB	Block-out Film 6 x 3
IMPR73S-BOB	Block-out Film 7 x 3
IMPR83S-BOB	Block-out Film 8 x 3

4 levels high

Art. nr.	Product
IMPR14S-BOB	Block-out Film 1 x 4
IMPR24S-BOB	Block-out Film 2 x 4
IMPR34S-BOB	Block-out Film 3 x 4
IMPR44S-BOB	Block-out Film 4 x 4
IMPR54S-BOB	Block-out Film 5 x 4
IMPR64S-BOB	Block-out Film 6 x 4
IMPR74S-BOB	Block-out Film 7 x 4
IMPR84S-BOB	Block-out Film 8 x 4

5 levels high

Art. nr.	Product
IMPR15S-BOB	Block-out Film 1 x 5
IMPR25S-BOB	Block-out Film 2 x 5
IMPR35S-BOB	Block-out Film 3 x 5
IMPR45S-BOB	Block-out Film 4 x 5

LED Light Set for Backlit Display

- EN**
- Separate LED light curtains for backlit display
 - Including 200, 240 or 320 watt transformer
 - Including silicone edged block-out film for bottom, top and sides
- DE**
- Separate LED-Lichtvorhänge für hintergrundbeleuchtetes Display
 - Inklusive 200, 240 oder 320 Watt Transformator
 - Inklusive Blockout-Folie mit Silikonabschluss für Unterseite, Oberseite und Seitenflächen
- NL**
- Losse LED lichtgordijnen voor backlit display
 - Inclusief 200, 240 of 320 watt transformator
 - Inclusief silicone edged block-out film voor bodem, top en zijkanten
- FR**
- Rideaux lumière LED pour backlit display
 - Avec transformateur de 200, 240 ou 320 watt
 - Avec silicone edged block-out film pour fond, haut et côtés
- ES**
- Cortinas de luz LED opcionales para obtener un display iluminado
 - Incluye transformador de 200, 240 o 320 watt
 - Incluye Blockout film con bordes de silicona para las partes inferior, superior y laterales del display



3 levels high

Art. nr.	Product
IMPR13S-LEDSET	LED Light Set 1 x 3
IMPR23S-LEDSET	LED Light Set 2 x 3
IMPR33S-LEDSET	LED Light Set 3 x 3
IMPR43S-LEDSET	LED Light Set 4 x 3
IMPR53S-LEDSET	LED Light Set 5 x 3
IMPR63S-LEDSET	LED Light Set 6 x 3
IMPR73S-LEDSET	LED Light Set 7 x 3
IMPR83S-LEDSET	LED Light Set 8 x 3

4 levels high

Art. nr.	Product
IMPR14S-LEDSET	LED Light Set 1 x 4
IMPR24S-LEDSET	LED Light Set 2 x 4
IMPR34S-LEDSET	LED Light Set 3 x 4
IMPR44S-LEDSET	LED Light Set 4 x 4
IMPR54S-LEDSET	LED Light Set 5 x 4
IMPR64S-LEDSET	LED Light Set 6 x 4
IMPR74S-LEDSET	LED Light Set 7 x 4
IMPR84S-LEDSET	LED Light Set 8 x 4

5 levels high

Art. nr.	Product
IMPR15S-LEDSET	LED Light Set 1 x 5
IMPR25S-LEDSET	LED Light Set 2 x 5
IMPR35S-LEDSET	LED Light Set 3 x 5
IMPR45S-LEDSET	LED Light Set 4 x 5

Pop-up Fabric



Optional velcro (6)

Product Velcro Loop (soft side)
 Art. nr. VEL50L
 Width 50mm
 Length 25m

Top view

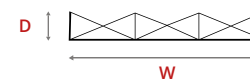

- ✓ Lightweight aluminium frame
- ✓ Quick and easy to assemble
- ✓ Levelling screws on bottom side

1

2: Case type A, see Trolley Case on page 167

3

4: Case type B, soft bag

5: Optional

6: Optional

Pop-Up Fabric

EN

- 50 mm white hook velcro (hard side) (1)
- Stable mobile trolley M / L / XL (2)
- Wide wheel base with ball bearing wheels (3)
- Padded bag with braces and zipper over full length (4)
- **Optional:** LED or halogen lighting (5)
- **Optional:** Loop velcro (soft side) available (6)

DE

- 50 mm weißes Klettband (1)
- Stabiler mobiler Trolley M / L / XL (2)
- Breiter Radstand mit kugellagererten Rädern (3)
- Verstärkte Tasche mit Innenfutter und Reißverschluss über die ganze Taschenlänge (4)
- **Optional:** LED- oder Halogenbeleuchtung (5)
- **Optional:** Flauschband erhältlich (6)

NL

- 50 mm witte klittenband (haak) (1)
- Stabiele verrijdbare trolley M / L / XL (2)
- Brede wielbasis met kogelgelagerde wielen (3)
- Gevoerde tas met ritsluiting over volledige lengte (4)
- **Optioneel:** LED of halogeenverlichting (5)
- **Optioneel:** Lus klittenband (zachte kant) beschikbaar (6)

FR

- Velcro male blanc 50 mm (côté dur) (1)
- Valise de transport stable M / L / XL (2)
- Position large des roues avec roulement à billes (3)
- Sac renforcé avec doublure et fermeture éclair sur toute la longueur (4)
- **Optionnel :** LED ou éclairage halogène (5)
- **Optionnel :** Velcro femelle (côte mou) disponible (6)

ES

- Velcro de gancho blanco (cara dura) 50 mm (1)
- Trolley estable M / L / XL (2)
- Amplia distancia entre ruedas con cojinete de bolas (3)
- Bolsa acolchada y reforzada con cremallera a todo el largo (4)
- **Opcional:** Iluminación LED o halógena (5)
- **Opcional:** Velcro de bucle (cara suave) disponible (6)

Product specifications

	Art. nr.	Frame	Dimensions			Trolley
			W	H	D	
CASETYPE A: TROLLEY CASE	PUF23S	2 x 3	151	224	30	M
	PUF33S	3 x 3	224	224	30	L
	PUF43S	4 x 3	297	224	30	L
	PUF53S	5 x 3	370	224	30	XL
CASETYPE B: SOFT BAG	PUF23S-SB	2 x 3	151	224	30	-
	PUF33S-SB	3 x 3	224	224	30	-
	PUF43S-SB	4 x 3	297	224	30	-
	PUF53S-SB	5 x 3	370	224	30	-

All sizes in cm.

Package specifications

	Outer box					Pallet capacity	
	PCS	W	H	D	KG	Euro	Industrial
CASETYPE A: TROLLEY CASE	1	39	97	39	12	12	12
	1	49	97	39	16	8	12
	1	49	97	39	17	8	12
	1	59	97	39	20	8	8
CASETYPE B: SOFT BAG	1	29	85	28	8	18	27
	1	29	85	28	10	18	27
	1	40	85	28	12	18	20
	1	40	85	28	14	18	20

No minimum order quantity.



Instructional video

Pop-up Fabric Premium

✓ Lightweight aluminium frame

✓ Available in straight and curved

✓ Fully equipped with Velcro dots for double-sided use



1: See Trolley Case on page 167



2: Optional



3: Optional, see chapter Lighting



4: Optional

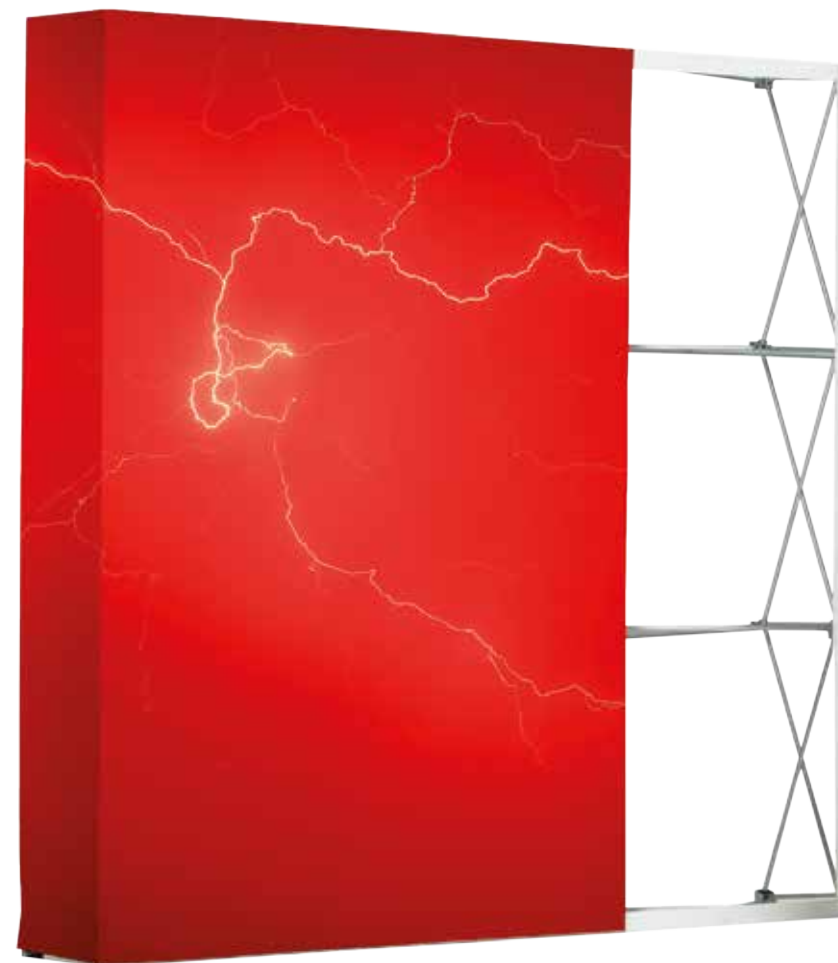

Pop-Up **Fabric Premium**

EN

- Backside fully equipped with velcro dots
- Stable mobile trolley M / L / XL (1)
- Wide wheel base with ball bearing wheels
- **Optional:** Rounded side panels, transporter bag included (2)
- **Optional:** LED or halogen lighting (3)
- **Optional:** Loop velcro (soft side) available (4)

DE

- Rückseite komplett ausgestattet mit Klettbandpunkten
- Stabiler mobiler Trolley M / L / XL (1)
- Breiter Radstand mit kugelgelagerten Rädern
- **Optional:** Gebogene Seitenteile inklusive Transporttasche (2)
- **Optional:** LED- oder Halogenbeleuchtung (3)
- **Optional:** Flauschband erhältlich (4)

NL

- Achterzijde volledig voorzien van klittenbandpunten
- Stabiele verrijdbare trolley M / L / XL (1)
- Brede wielbasis met kogelgelagerde wielen
- **Optioneel:** Gebogen zijpanelen inclusief transporttas (2)
- **Optioneel:** LED of halogeenverlichting (3)
- **Optioneel:** Lus klittenband (zachte kant) beschikbaar (4)

FR

- Verso complètement équipé de points velcro
- Stables valise de transport M / L / XL (1)
- Position large des roues avec roulement à billes
- **Optionnel :** Panneaux latéraux, sac de transport inclus (2)
- **Optionnel :** LED ou éclairage halogène (3)
- **Optionnel :** Velcro femelle (côte mou) disponible (4)

ES

- Parte de atrás completamente equipada de puntos de velcro
- Trolley estable M / L / XL (1)
- Amplia distancia entre ruedas con cojinete de bolas
- **Opcional:** Laterales curvados y bolsa de transporte (2)
- **Opcional:** Iluminación LED o halógena (3)
- **Opcional:** Velcro de bucle (cara suave) disponible (4)

Top view Straight (S)



Top view Curved (C)

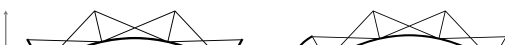

D

W1

W1: WITHOUT SIDE PANELS

W2

W2: INCLUDING SIDE PANELS

Optional velcro (4)

Product Velcro LOOP (soft side)
Art. nr. VEL50L
Width 50mm
Length 25m

Optional side panels

Product Rounded side panels
Art. nr. PUFPR

Product specifications

	Art. nr.	Frame	Dimensions				Trolley
			W1	W2	H	D	
STRAIGHT	PUFP23S	2 x 3	148	184	220	36	M
	PUFP33S	3 x 3	220	256	220	36	L
	PUFP43S	4 x 3	292	328	220	36	L
	PUFP53S	5 x 3	363	399	220	36	XL
CURVED	PUFP23C	2 x 3	158	182	220	44	M
	PUFP33C	3 x 3	228	252	220	52	L
	PUFP43C	4 x 3	298	322	220	66	L
	PUFP53C	5 x 3	368	392	220	82	XL

All sizes in cm.

Package specifications

	Outer box					Pallet capacity	
	PCS	W	H	D	KG	Euro	Industrial
STRAIGHT	1	39	97	39	13	12	12
	1	49	97	39	16	8	12
	1	49	97	39	18	8	12
	1	59	97	39	21	8	8
CURVED	1	39	97	39	13	12	12
	1	49	97	39	16	8	12
	1	49	97	39	18	8	12
	1	59	97	39	21	8	8

No minimum order quantity.



Instructional video

Pop-up Magnetic



2: Case type A



3: Case type B



4: Optional, see page 25



5: Optional, see chapter Lighting



Instructional video

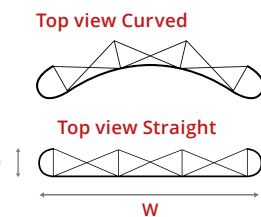

Pop-Up Magnetic

- EN**
- Handy click system with reinforced 12-mm power magnets (1)
 - Mobile hard case with firm divider to protect the prints (2)
 - Padded trolley with tube bag to protect the print (3)
 - **Optional:** Table top in 4 colours for hard case (4)
 - **Optional:** LED or halogen lighting (5)

- DE**
- Praktisches Klicksystem mit verstärkten 12-mm-Magneten (1)
 - Mobiler Transportkoffer mit Abtrennung zum Schutz der Drucke (2)
 - Gepolsterter Trolley mit extra Tasche zum Schutz der Drucke (3)
 - **Optional:** Thekenplatte in 4 Farben für Transportkoffer (4)
 - **Optional:** LED- oder Halogenbeleuchtung (5)

- NL**
- Handig kliksysteem met versterkte 12 mm magneten (1)
 - Verrijdbare hardcase met scheidingspaneel voor bescherming print (2)
 - Gevoerde trolley met kokertas voor bescherming print (3)
 - **Optioneel:** Balieblad in 4 kleuren voor hardcase (4)
 - **Optioneel:** LED of halogeenverlichting (5)

- FR**
- Système de clipsage pratique avec aimants renforcés de 12 mm (1)
 - Valise rigide avec séparateur fixe afin de protéger les visuels (2)
 - Valise souple rembourée avec tube de protection pour les visuels (3)
 - **Optionnel :** Tablette supérieure de 4 couleurs pour valise rigide (4)
 - **Optionnel :** LED ou éclairage halogène (5)

- ES**
- Cómodo sistema de clic con imanes reforzados de 12 mm (1)
 - Maleta rígida con separador firme para proteger los paneles (2)
 - Trolley acolchada con estuche tubular para proteger la impresión (3)
 - **Opcional:** Tablero del mostrador en 4 colores para la maleta rígida (4)
 - **Opcional:** Iluminación LED o halógena (5)

Attention: See next page for options

Product specifications

	Dimensions		
	W	H	D
HARD CASE	Art. nr.	Art. nr.	
	PUM23C	PUM23C-ST	192 224 51
	PUM33C	PUM33C-ST	252 224 69
	PUM43C	PUM43C-ST	301 224 100
SOFT TROLLEY	PUM53C	PUM53C-ST	341 224 129
	PUM23S	PUM23S-ST	197 224 32
	PUM33S	PUM33S-ST	270 224 32
	PUM43S	PUM43S-ST	343 224 32
PUM53S	PUM53S-ST	417 224 32	

All sizes in cm.

Package specifications

	Outer box					Pallet capacity			
	PCS	W	H	D	KG	HARD CASE		SOFT TROLLEY	
						Euro	Industrial	Euro	Industrial
CURVED	1	42	100	71	27	4	6	8	12
	1	42	100	71	29	4	6	8	12
	1	42	100	71	31	4	6	8	10
	1	42	100	71	33	4	6	8	10
STRAIGHT	1	42	100	71	27	4	6	8	12
	1	42	100	71	29	4	6	8	12
	1	42	100	71	31	4	6	8	10
	1	42	100	71	33	4	6	8	10

No minimum order quantity.

Pop-up

Magnetic Options

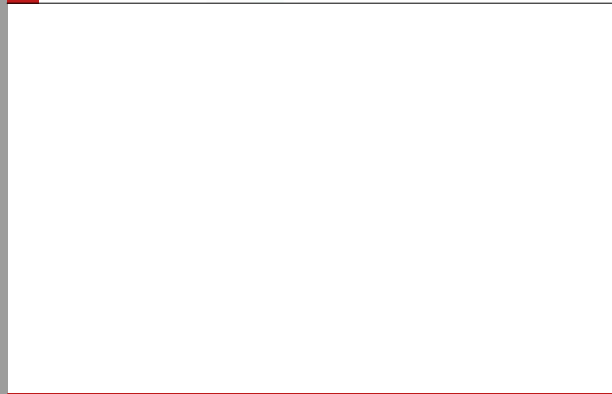

Extra kit for new visuals

- EN**
- Plastic top strips (hangers) and plastic bottom strips (kickers) (1)
 - Magnetic tape (3-poles) with strong TESA self-adhesive (2)
- DE**
- Kunststoffstreifen oben (Hängers) und Kunststoffstreifen unten (Kickers) (1)
 - Magnetband (3-Polig) mit TESA-film (2)
- NL**
- Kunststof bovenstrips (hangers) en kunststof onderstrips (kickers) (1)
 - Magneetband (3-Polig) met sterke TESA tape (2)
- FR**
- Bandes plastiques haut et bas (1)
 - Bande magnétique (3 pôles) avec adhésif TESA (2)
- ES**
- Railes de plástico arriba (hangers) y abajo (kickers) (1)
 - Cinta magnética (3 polos) con autoadhesivo TESA (2)

CURVED	STRAIGHT	
Art. nr.	Art. nr.	Size
PUM23CKIT	PUM23SKIT	2 x 3
PUM33CKIT	PUM33SKIT	3 x 3
PUM43CKIT	PUM43SKIT	4 x 3
PUM53CKIT	PUM53SKIT	5 x 3

Bag for new / backside visuals

- EN** Extra tube bag to protect the print
- DE** Extra Tasche zum Schutz der Drucke
- NL** Extra kokertas voor bescherming print
- FR** Sac supplémentaire pour protéger les visuels
- ES** Estuche tubular adicional para proteger el visual

Art. nr.	Ø	H
PUM-BAGV5	27,5	80
<i>Bag for new visuals max 5 panels</i>		
PUM-BAGV7	30,5	80
<i>Bag for new visuals max 7 panels</i>		
PUM-BAGV5B	27,5	87
<i>Bag for backside visuals max 5 panels</i>		

All sizes in cm.



Table Top

- EN**
- Table top in 4 colours
 - Easily collapsible (1)
 - Padded bag with zipper (2)
- DE**
- Thekenplatte in 4 Farben
 - Einfach einklappbar (1)
 - Tasche mit Innenfutter und Reißverschluss (2)
- NL**
- Balieblad in 4 kleuren
 - Gemakkelijk inklapbaar (1)
 - Tas met binnenvoering en ritsluiting (2)
- FR**
- Tablette supérieure de 4 couleurs
 - Repli facilité (1)
 - Sac rembourré avec fermeture éclair (2)
- ES**
- Tablero de mostrador en 4 colores
 - Fácil de plegar (1)
 - Bolsa acolchada con cremallera (2)



Art. nr.	Colour	Product
PUMTTB	●	Table Top Black
PUMTTW	●	Table Top Wood
PUMTTS	●	Table Top Silver
PUMTTWH	○	Table Top White

Extension kit for backside

- EN**
- Magnetic bar with 5-poles magnetic tape (1)
 - Magnets for backside frame (2)
- DE**
- Magnetschiene mit 5-poligem Magnetband (1)
 - Magnet für Rückseite (2)
- NL**
- Magneetbar met 5-polige magneettape (1)
 - Magneten voor achterzijde frame (2)
- FR**
- Barre magnétique avec bande magnétique 5 pôles (1)
 - Aimants au verso du cadre (2)
- ES**
- Barra magnética con cinta magnética 5 polos (1)
 - Imanes para uso en la parte de atrás de la estructura (2)

CURVED	STRAIGHT	
Art. nr.	Art. nr.	Size
PUM23CE	PUM23SE	2 x 3
PUM33CE	PUM33SE	3 x 3
PUM43CE	PUM43SE	4 x 3
PUM53CE	PUM53SE	5 x 3



Pop-up Tower



1: Patented



2



3



4



5: Optional, see chapter Lighting

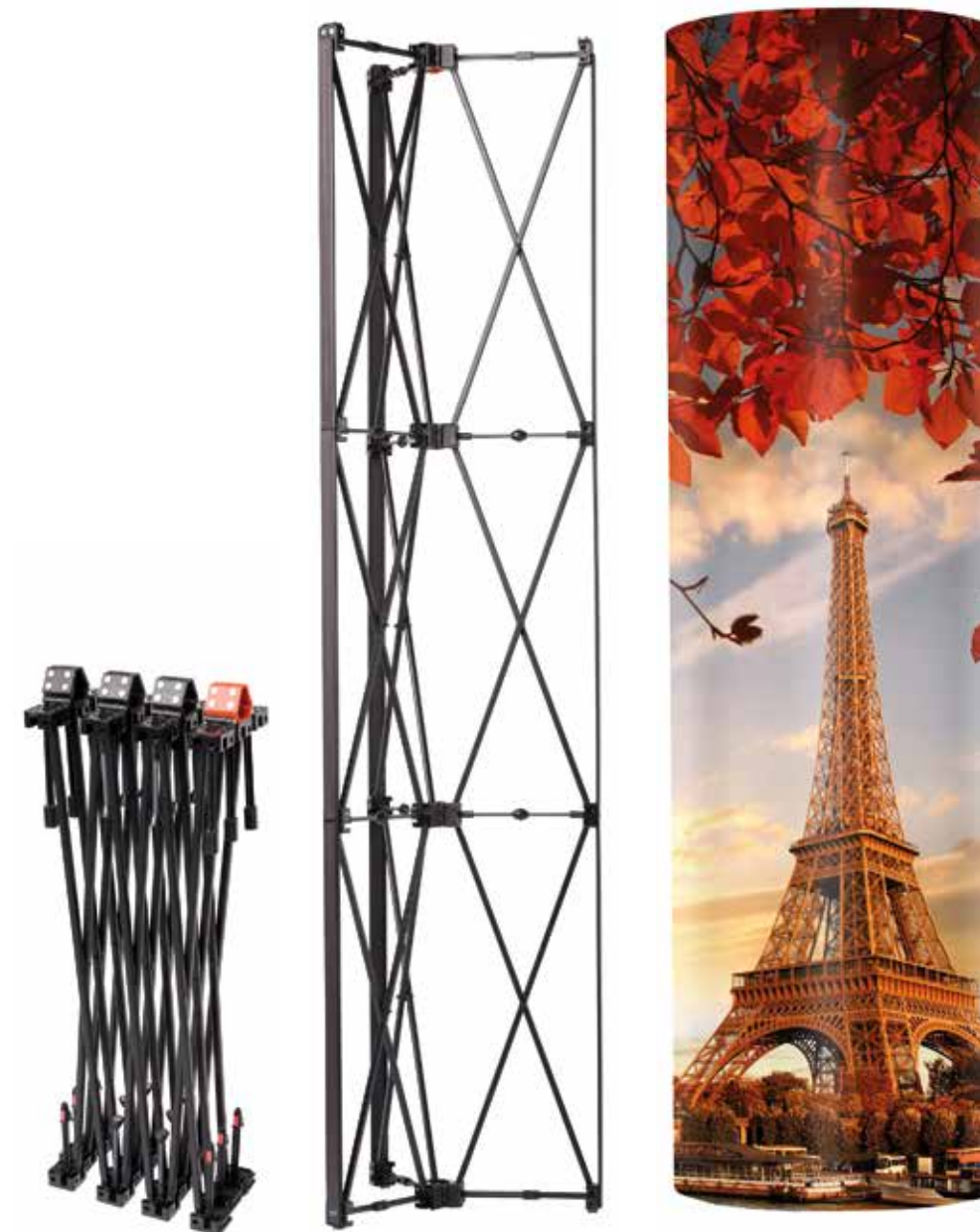

Extra kit for new visuals (4)

Art. nr. PUTWRKIT Product Extra kit for new visuals

Pop-Up Tower

EN

- Aluminium frame with patented hinges and magnetic locking (1)
- Padded trolley with tube bag to protect the print (2)
- Equipped with fixation for light (3)
- Including:** Extra kit for new visuals, including plastic top strips (hangers) and magnetic tape (3-poles) with strong TESA self-adhesive (4)
- Optional:** LED or halogen lighting (5)

DE

- Aluminiumrahmen mit patentierten Scharnieren und Magnetverriegelung (1)
- Gepolsteter Trolley mit extra Tasche zum Schutz der Drucke (2)
- Standardmäßig geliefert mit Befestigungssystem für die Beleuchtung (3)
- Einschließlich:** Zusatzkit für neue Visuals, mit Kunststoffstreifen oben (Hänger) und Magnetband (3-Polig) mit starkem TESA-Film (4)
- Optional:** LED- oder Halogenbeleuchtung (5)

NL

- Aluminium frame met gepatenteerde scharnieren en magneetsluiting (1)
- Gevoerde trolley met kokertas voor bescherming print (2)
- Standaard voorzien van bevestigingssysteem voor verlichting (3)
- Inclusief:** Extra kit voor nieuwe visuals, met kunststof bovenstrips (hangers) en magneetband (3-polig) met sterke TESA tape (4)
- Optioneel:** LED of halogeenverlichting (5)

FR

- Structure aluminium avec charnière et fixation magnétique brevetées (1)
- Valise souple rembourée avec tube de protection pour les visuals (2)
- Fourni avec système de fixation pour lampe (3)
- Y compris :** Kit supplémentaire pour nouveaux visuals, avec bandes supérieures plastique (hangers) et bande magnétique (3 pôles) avec adhésif TESA (4)
- Optionnel :** LED ou éclairage halogène (5)

ES

- Estructura de aluminio con bisagras y cierre magnética patentadas (1)
- Trolley acolchada con estuche tubular para proteger la impresión (2)
- Equipado con punto de fijación para iluminación (3)
- Incluyendo:** Kit adicional para visuales nuevos, con raíles superiores de plástico (hangers) y cinta magnética (3 polos) con autoadhesivo TESA (4)
- Opcional:** Iluminación LED o halógena (5)

Product specifications

Art. nr.	Dimensions	
	Ø	H
PUTWR	64	225

All sizes in cm.

Package specifications

Art. nr.	Outer box					Pallet capacity	
	PCS	W	H	D	KG	Euro	Industrial
PUTWR	1	30	91	43	16,5	12	16



Zipper-Walls

Curved	30
Straight	32
Arch	34
Moon	36
Banner	38
Sizes	40

Zipper-Wall Curved



1



2



3



4



5



4: Optional, see chapter Lighting



5: Optional



Zipper-Wall **Curved**

EN

- Anodised aluminium (Ø 34 mm) (1)
- Support pole (Ø 24 mm) with security clip (2)
- Reinforced transport trolley for durable professional use with ball bearing wheels (3)
- **Optional:** LED or halogen lighting (4) with clamp (5)

DE

- Eloxiertes Aluminium (Ø 34 mm) (1)
- Stabilisierungsstange (Ø 24 mm) mit Sicherheitsclip (2)
- Verstärkter Transporttrolley für Langzeitgebrauch mit kugelgelagerten Rädern (3)
- **Optional:** LED- oder Halogenbeleuchtung (4) mit Klemme (5)

NL

- Geanodiseerd aluminium (Ø 34 mm) (1)
- Ondersteuningspaal (Ø 24 mm) met borgveer (2)
- Verstevigde transporttrolley met gekogellagerde wielen, voor langdurig professioneel gebruik (3)
- **Optioneel:** LED of halogeenverlichting (4) met klem (5)

FR

- Aluminium anodisé (Ø 34 mm) (1)
- Support de mât (Ø 24 mm) avec clip de sécurité (2)
- Valise de transport renforcée pour une utilisation professionnelle durable avec roulettes à roulement à billes (3)
- **Optionnel :** lumières LED ou halogènes (4) avec clip (5)

ES

- Aluminio anodizado (Ø 34 mm) (1)
- Poste de soporte (Ø 24 mm) con clip de seguridad (2)
- Trolley de transporte reforzado para un uso duradero y profesional con ruedas con cojinetes (3)
- **Opcional:** iluminación LED o halógena (4) con abrazadera (5)

! Important: Available in 9 sizes

Width: Between 300 and 500 cm
Height: Between 100 and 230 cm

Example: ZWC300-230:
Width 300 cm and height 230 cm

Product specifications

Art. nr.	Dimensions			Trolley
	W	H	D	
ZWC300-100	300	100	60	M
ZWC400-100	400	100	80	L
ZWC500-100	500	100	100	L
ZWC300-150	300	150	60	L
ZWC400-150	400	150	80	L
ZWC500-150	500	150	100	L
ZWC300-230	300	230	60	L
ZWC400-230	400	230	80	XL
ZWC500-230	500	230	100	XL

All sizes in cm.

Package specifications

Art. nr.	Outer box				
	PCS	W	H	D	KG
ZWC300-100	1	33	132	19	8,7
ZWC400-100	1	33	132	23	9,5
ZWC500-100	1	33	132	23	9,5
ZWC300-150	1	33	132	23	10,1
ZWC400-150	1	33	132	23	11
ZWC500-150	1	33	132	23	11
ZWC300-230	1	33	132	23	10,4
ZWC400-230	1	33	132	28	11,4
ZWC500-230	1	33	132	28	14

Pallet capacity

Euro	Industrial
12	16
12	16
12	16
12	16
12	16
12	16
11	12
11	12

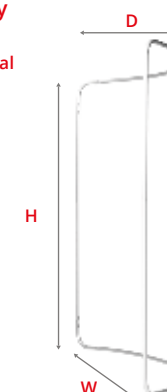

Instructional video

Zipper-Wall Straight



Zipper-Wall **Straight**

EN

- Anodised aluminium (Ø 34 mm) (1)
- Support pole (Ø 24 mm) with security clip (2)
- Reinforced transport trolley for durable professional use with ball bearing wheels (3)
- **Optional:** LED or halogen lighting (4) with clamp (5)

DE

- Eloxiertes Aluminium (Ø 34 mm) (1)
- Stabilisierungsstange (Ø 24 mm) mit Sicherheitsclip (2)
- Verstärkter Transporttrolley für Langzeitgebrauch mit kugelgelagerten Rädern (3)
- **Optional:** LED- oder Halogenbeleuchtung (4) mit Klemme (5)

NL

- Geanodiseerd aluminium (Ø 34 mm) (1)
- Ondersteuningspaal (Ø 24 mm) met borgveer (2)
- Versterkte transporttrolley voor langdurig professioneel gebruik met kogelgelagerde wielen (3)
- **Optioneel:** LED of halogeenverlichting (4) met klem (5)

FR

- Aluminium anodisé (Ø 34 mm) (1)
- Support de mât (Ø 24 mm) avec clip de sécurité (2)
- Valise de transport renforcée pour une utilisation professionnelle durable avec roulette à roulement à billes (3)
- **Optionnel :** lumières LED ou halogènes (4) avec clip (5)

ES

- Aluminio anodizado (Ø 34 mm) (1)
- Poste de soporte (Ø 24 mm) con clip de seguridad (2)
- Trolley de transporte reforzado para un uso durable y profesional con cojinete de bolas (3)
- **Opcional:** iluminación LED o halógena (4) con abrazadera (5)

Important: Available in 30 sizes

Width: Between 100 and 600 cm
Height: Between 100 and 300 cm

Example: ZWS300-230:
Width 300 cm and height 230 cm

- ✓ Available in 30 sizes
- ✓ For single- or double-sided use
- ✓ Large visual graphic area



Product specifications

Art. nr.	Dimensions			Trolley
	W	H	D	
ZWS100-100	100	100	45	M
ZWS150-100	150	100	45	M
ZWS200-100	200	100	45	M
ZWS250-100	250	100	45	M
ZWS300-100	300	100	45	L
ZWS400-100	400	100	45	L
ZWS500-100	500	100	45	XL
ZWS600-100	600	100	45	XL
ZWS100-150	100	150	45	M
ZWS150-150	150	150	45	M
ZWS200-150	200	150	45	M
ZWS250-150	250	150	45	M
ZWS300-150	300	150	45	L
ZWS400-150	400	150	45	L
ZWS500-150	500	150	45	XL
ZWS600-150	600	150	45	XL
ZWS100-230	100	230	45	M
ZWS150-230	150	230	45	M
ZWS200-230	200	230	45	M
ZWS250-230	250	230	45	L
ZWS300-230	300	230	45	L
ZWS400-230	400	230	45	XL
ZWS500-230	500	230	45	XL
ZWS600-230	600	230	45	XL
ZWS100-250	100	250	45	M
ZWS150-250	150	250	45	M
ZWS200-250	200	250	45	M
ZWS100-300	100	300	45	L
ZWS150-300	150	300	45	L
ZWS200-300	200	300	45	L

All sizes in cm.

Package specifications

Art. nr.	Outer box					Pallet capacity	
	PCS	W	H	D	KG	Euro	Industrial
ZWS100-100	1	33	132	19	9,5	14	19
ZWS150-100	1	33	132	19	10,1	14	19
ZWS200-100	1	33	132	19	10,4	14	19
ZWS250-100	1	33	132	19	11,1	14	19
ZWS300-100	1	33	132	23	12	12	16
ZWS400-100	1	33	132	23	14,5	12	16
ZWS500-100	1	33	132	28	16,1	11	12
ZWS600-100	1	33	132	28	16,8	11	12
ZWS100-150	1	33	132	19	10,1	14	19
ZWS150-150	1	33	132	19	10,2	14	19
ZWS200-150	1	33	132	19	10,8	14	19
ZWS250-150	1	33	132	19	11,5	14	19
ZWS300-150	1	33	132	23	13	12	16
ZWS400-150	1	33	132	23	15	12	16
ZWS500-150	1	33	132	28	16,4	11	12
ZWS600-150	1	33	132	28	17,5	11	12
ZWS100-230	1	33	132	19	10,7	14	19
ZWS150-230	1	33	132	19	10,7	14	19
ZWS200-230	1	33	132	19	11,3	14	19
ZWS250-230	1	33	132	23	12,9	12	16
ZWS300-230	1	33	132	23	13,3	12	16
ZWS400-230	1	33	132	28	16,6	11	12
ZWS500-230	1	33	132	28	17,8	11	12
ZWS600-230	1	33	132	28	18,6	11	12
ZWS100-250	1	33	132	19	11,1	14	19
ZWS150-250	1	33	132	19	11,4	14	19
ZWS200-250	1	33	132	19	12,1	14	19
ZWS100-300	1	33	132	23	12	12	16
ZWS150-300	1	33	132	23	12,5	12	16
ZWS200-300	1	33	132	23	13	12	16

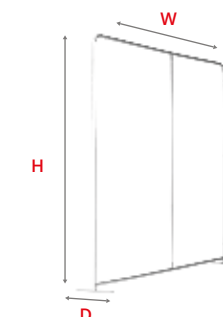

30



Instructional video

Zipper-Wall Arch



4: Optional, see chapter Lighting

5: Optional



Zipper-Wall Arch

EN

- Anodised aluminium (Ø 34 mm) (1)
- Solid powder coated steel base
- Support pole (Ø 24 mm) with security clip (2)
- Reinforced transport trolley for durable professional use with ball bearing wheels (3)
- **Optional:** LED or halogen lighting (4) with clamp (5)

DE

- Eloxiertes Aluminium (Ø 34 mm) (1)
- Solider pulverbeschichteter Stahlfuß
- Stabilisierungsstange (Ø 24 mm) mit Sicherheitsclip (2)
- Verstärkter Transporttrolley für Langzeitgebrauch mit kugelgelagerten Rädern (3)
- **Optional:** LED- oder Halogenbeleuchtung (4) mit Klemme (5)

NL

- Geanodiseerd aluminium (Ø 34 mm) (1)
- Stevige gepoedercoate stalen voet
- Ondersteuningspaal (Ø 24 mm) met borgveer (2)
- Verstevigde transporttrolley voor langdurig professioneel gebruik met kogelgelagerde wielen (3)
- **Optioneel:** LED of halogeenverlichting (4) met klem (5)

FR

- Aluminium anodisé (Ø 34 mm) (1)
- Base résistante avec revêtement poudré
- Support de mât (Ø 24 mm) avec clip de sécurité (2)
- Valise de transport renforcée pour une utilisation professionnelle durable avec roulette à roulement à billes (3)
- **Optionnel :** lumières LED ou halogènes (4) avec clip (5)

ES

- Aluminio anodizado (Ø 34 mm) (1)
- Base sólida lacado en mate
- Poste de soporte (Ø 24 mm) con clip de seguridad (2)
- Trolley de transporte reforzado para un uso durable y profesional con cojinete de bolas (3)
- **Opcional:** iluminación LED o halógena (4) con abrazadera (5)

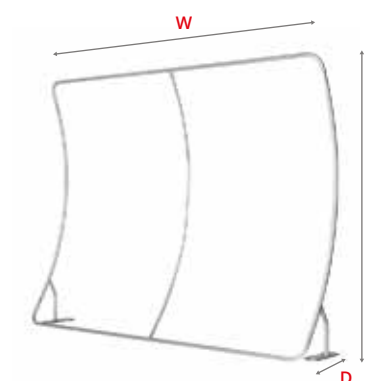

Important: Available in 8 sizes

Width: Between 100 and 600 cm
Height: 230 cm

Example: ZWA300-230:
Width 300 cm and height 230 cm

Product specifications

Art. nr.	Dimensions			Trolley
	W	H	D	
ZWA100-230	100	230	50	XL
ZWA150-230	150	230	50	XL
ZWA200-230	200	230	50	XL
ZWA250-230	250	230	50	XL
ZWA300-230	300	230	50	XL
ZWA400-230	400	230	50	XL
ZWA500-230	500	230	50	XL
ZWA600-230	600	230	50	XL

All sizes in cm.

Package specifications

Outer box	PCS	W	H	D	KG
	1	33	132	28	15,1
	1	33	132	28	15,1
	1	33	132	28	15,9
	1	33	132	28	16,7
	1	33	132	28	17
	1	33	132	28	17,9
	1	33	132	28	18,9
	1	33	132	28	19,7

Pallet capacity

Euro	Industrial
11	12
11	12
11	12
11	12
11	12
11	12
11	12
11	12



Instructional video

Zipper-Wall Moon

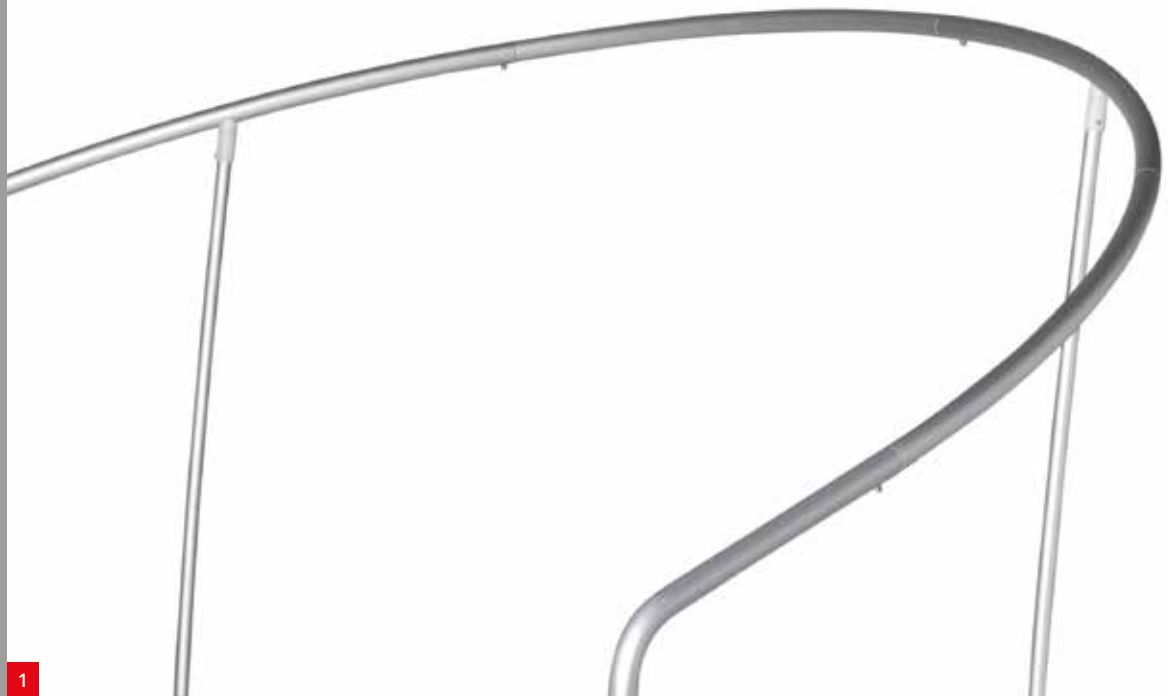

1

2

3

4: Optional, see chapter Lighting

5: Optional



Zipper-Wall Moon

EN

- Anodised aluminium (Ø 34 mm) (1)
- Extremely stable due to smooth bended curve
- Support pole (Ø 24 mm) with security clip (2)
- Reinforced transport trolley for durable professional use with ball bearing wheels (3)
- **Optional:** LED or halogen lighting (4) with clamp (5)

DE

- Eloxiertes Aluminium (Ø 34 mm) (1)
- Extrem stabil mit hoher Standfestigkeit aufgrund gekrümmter Form
- Stabilisierungsstange (Ø 24 mm) mit Sicherheitsclip (2)
- Verstärkter Transporttrolley für Langzeitgebrauch mit kugelgelagerten Rädern (3)
- **Optional:** LED- oder Halogenbeleuchtung (4) mit Klemme (5)

Top view

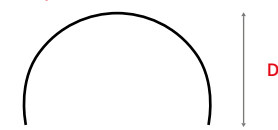

NL

- Geanodiseerd aluminium (Ø 34 mm) (1)
- Erg stabiel door vloeiend gebogen curve
- Ondersteuningspaal (Ø 24 mm) met borgveer (2)
- Verstevigde transporttrolley voor langdurig professioneel gebruik met kogelgelagerde wielen (3)
- **Optioneel:** LED of halogeenverlichting (4) met klem (5)

FR

- Aluminium anodisé (Ø 34 mm) (1)
- Stabilité renforcée grâce à sa forme courbée
- Support de mât (Ø 24 mm) avec clip de sécurité (2)
- Valise de transport renforcée pour une utilisation professionnelle durable avec roulette à roulement à billes (3)
- **Optionnel :** lumières LED ou halogènes (4) avec clip (5)

ES

- Aluminio anodizado (Ø 34 mm) (1)
- Extremadamente estable por su forma curvada
- Poste de soporte (Ø 24 mm) con clip de seguridad (2)
- Trolley de transporte reforzado para un uso durable y profesional con cojinete de bolas (3)
- **Optional:** iluminación LED o halógena (4) con abrazadera (5)

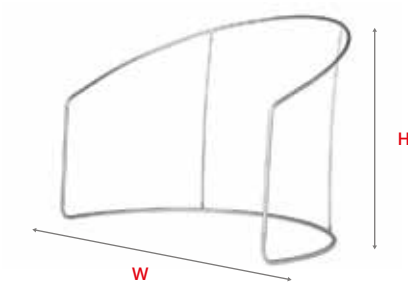

Product specifications

Art. nr.	Dimensions			Trolley
	W	H	D	
ZW-Moon	280	200	170	XL

All sizes in cm.

Package specifications

Outer box	Pallet capacity						
		PCS	W	H	D	KG	Euro
1	11	33	132	28	12,8	11	12



Instructional video

Zipper-Wall Banner



1



2



3



4: Optional, see chapter Lighting



5: Optional



Zipper-Wall Banner

EN

- Anodised aluminium (Ø 34 mm) (1)
- Black steel plate, available in 3 width measurements (2)
- Padded bag with braces and zipper over full length (3)
- **Optional:** LED or halogen lighting (4) with clamp (5)

DE

- Eloxiertes Aluminium (Ø 34 mm) (1)
- Schwarze Stahlplatte erhältlich in 3 Größen (2)
- Verstärkte Tasche mit Innenfutter und Reißverschluss über die ganze Taschenlänge (3)
- **Optional:** LED- oder Halogenbeleuchtung (4) mit Klemme (5)

NL

- Geanodiseerd aluminium (Ø 34 mm) (1)
- Zwarte staalplaat in 3 breedtematen (2)
- Gevoerde tas met binnenvoering en ritsluiting over volledige lengte (3)
- **Optioneel:** LED of halogeenverlichting (4) met klem (5)

FR

- Aluminium anodisé (Ø 34 mm) (1)
- Plaque en acier noir disponible en 3 largeurs (2)
- Sac renforcé avec doublure et fermeture éclair sur toute la longueur (3)
- **Optionnel :** lumières LED ou halogènes (4) avec clip (5)

ES

- Aluminio anodizado (Ø 34 mm) (1)
- Placa de acero negro, disponible en 3 anchos distintos (2)
- Bolsa acolchada y reforzada con cremallera a todo lo largo (3)
- **Opcional:** iluminación LED o halógena (4) con abrazadera (5)

Important: Available in 7 sizes

Width: Between 60 and 100 cm
Height: Between 150 and 300 cm

Example: ZWB100-200:
Width 100 cm and height 200 cm

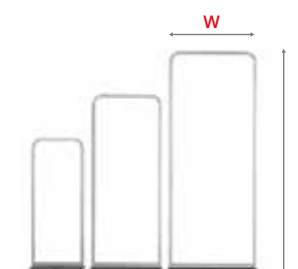

Product specifications

Art. nr.	Dimensions			Steel plate Size
	W	H	D	
ZWB060-150	60	150	25	61 x 25
ZWB060-200	60	200	25	61 x 25
ZWB080-150	80	150	25	81 x 25
ZWB080-200	80	200	25	81 x 25
ZWB100-200	100	200	25	101 x 25
ZWB100-250	100	250	25	101 x 25
ZWB100-300	100	300	25	101 x 25

All sizes in cm.

Package specifications

Outer box PCS	Outer box			
	W	H	D	KG
1	64	28	14	6,3
1	64	28	14	6,3
1	84	28	14	7,9
1	84	28	14	8,3
1	104	28	14	9,9
1	104	28	14	10,1
1	104	28	14	10,6

Pallet capacity

Euro	Industrial
64	84
64	84
45	65
45	65
40	52
40	52
40	52



Instructional video

Zipper-Wall Sizes

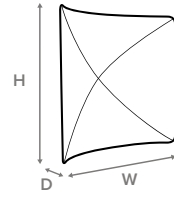

Zipper-Wall **Curved**

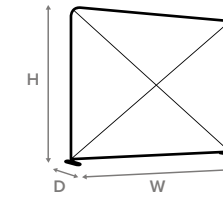
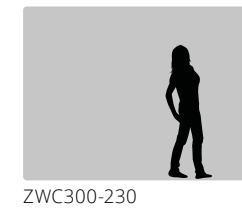
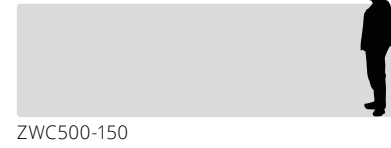
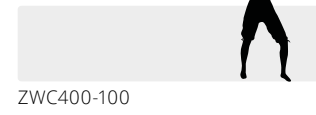
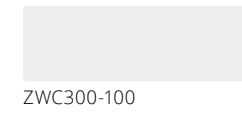

Zipper-Wall **Straight**

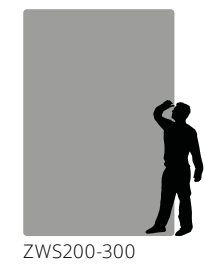
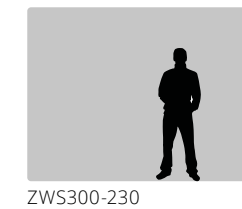
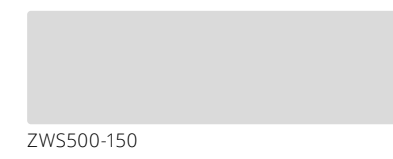
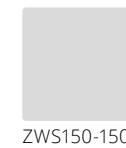
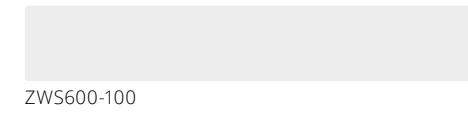
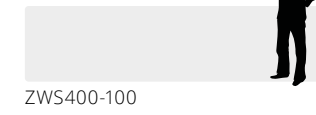
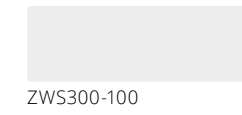
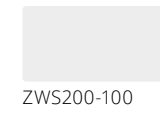
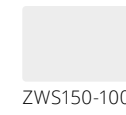
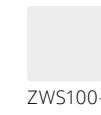

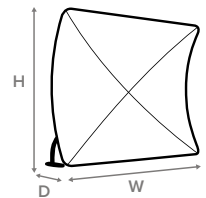

Zipper-Wall Arch

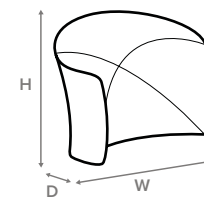
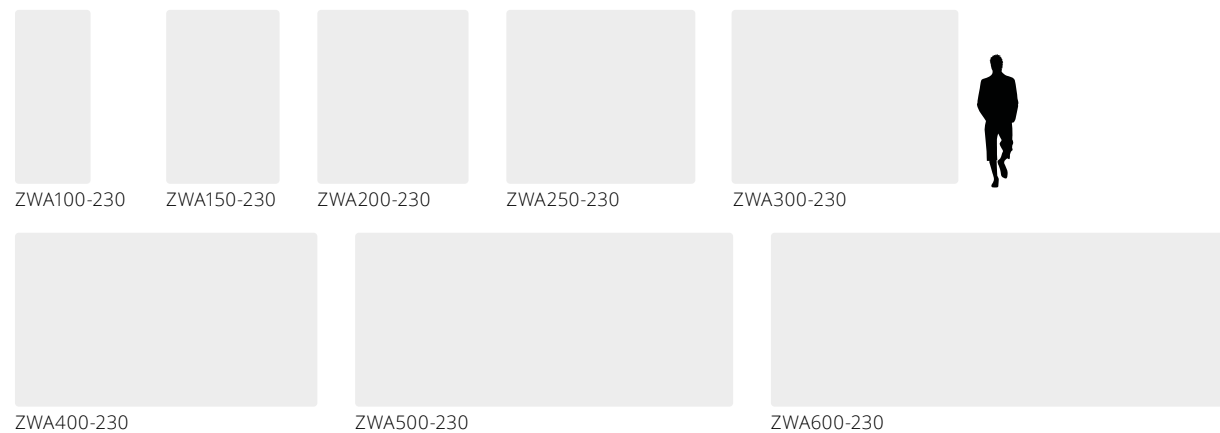

Zipper-Wall Moon

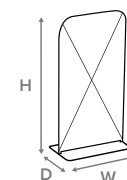

Zipper-Wall Banner

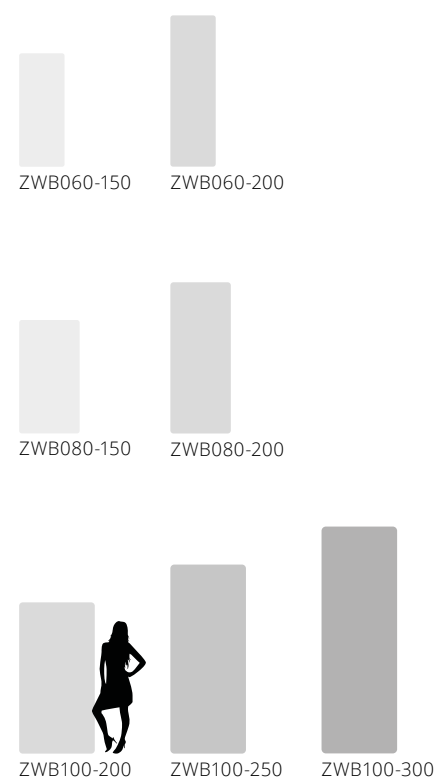





















































Roll-Banners

Our favourite range

Of course, all our Banners are our favorites. But if we'd had to pick 3, this would be our selection.

Roll-Banners with a great price-quality ratio, an outstanding look and a little something extra.

	Selection table	
	Cube	48
<i>Favourite range</i>	Budget	50
	Challenger	52
	Basic	54
	Plus	56
<i>Favourite range</i>	Triangle	58
	Evolution	60
<i>Favourite range</i>	Delight	62
	Premium	64
	Massive	66
	Deluxe	68
	Twin	70
	Double	72
	Extreme	74
	Mini	76

		Page	Side view	Width	Height	Weight of product	Double sided printing	Number of poles	Telescopic pole	Height description on pole	Adhesive on bottom	Snap profile on bottom	Number of feet	Foot type (shape like)	Top profile type	Bag type	Foot type	Top profile type	Bag type
Cube		48		60 80 85 100	200 200 200 200	1,6 1,9 2 2,2		1 1 1 1			x x x x		1 1 1 1	F1 F1 F1 F1	P1 P1 P1 P1	B1 B1 B1 B1			
Budget	Our favourite	50		80 85 100	200 200 200	1,8 1,9 2,1		1 1 1			x x x		2 2 2	F3 F3 F3	P2 P2 P2	B1 B1 B1			
Challenger Alu		52		80 85 100	200 200 200	2 2,1 2,3		1 1 1			x x x		2 2 2	F2 F2 F2	P1 P1 P1	B3 B3 B3			
Challenger Next		52		80 85 100	200 200 200	2 2,1 2,3		1 1 1			x x x		2 2 2	F3 F3 F3	P1 P1 P1	B3 B3 B3			
Challenger Black		52		85 100	200 200	2,1 2,3		1 1			x x		2 2	F2 F2	P1 P1	B3 B3			
Basic 1 foot		54		60 80 85 100	200 200 200 200	2,3 2,8 2,8 3,2		1 1 1 1			x x x x		1 1 1 1	F2 F2 F2 F2	P2 P2 P2 P2	B4 B4 B4 B4			
Basic 2 feet		54		80 85 100 120	200 200 200 200	2,8 2,8 3,2 3,9		1 1 1 2			x x x x		2 2 2 2	F2 F2 F2 F2	P2 P2 P2 P2	B4 B4 B4 B4			
Basic Black		54		85 100	200 200	2,8 3,2		1 1			x x		2 2	F2 F2	P2 P2	B4 B4			
Plus		56		40 60 80 85 100 100 120 150	200 200 200 200 200 200 200 200	1,6 2,2 2,2 2,8 3,2 3,2 4,1 4,8		1 1 1 1 1 2 2 2			x x x x x x x x		1 2 2 2 2 2 2 2	F3 F3 F3 F3 F3 F3 F3 F3	P2 P2 P2 P2 P2 P2 P2 P2	B2 B2 B2 B2 B2 B2 B2 B2			
Triangle	Our favourite	58		85 100 120 150	160-220 160-220 160-220 160-220	3,5 3,8 5,2 6,1		1 1 2 2	x x x x		x x x x		1 1 2 2	F4 F4 F4 F4	P2 P2 P2 P2	B4 B4 B4 B4			
Evolution		60		85 100 120 150	160-220 160-220 160-220 160-220	3,6 4,1 4,9 6		1 1 1 2	x x x x		x x x x		1 1 2 2	F5 F5 F5 F5	P3 P3 P3 P3	B4 B4 B4 B4			
Delight	Our favourite	62		85	200	4,2		1			x		0		P2	B5			
Premium		64		85 100 120 150	160-220 160-220 160-220 160-220	5,7 6,8 8,3 10		1 1 1 2	x x x x		x x x x		0 0 0 0		P3 P3 P3 P3	B5 B5 B5 B5			
Premium Black		64		85 100	160-220 160-220	5,7 6,8		1 1	x x		x x		0 0		P3 P3	B5 B5			
Massive		66		85 100 120 150	160-220 160-220 160-220 160-220	4,1 5 6,3 7,6		1 1 1 2	x x x x		x x x x		1 1 2 2	F6 F6 F6 F6	P3 P3 P3 P3	B4 B4 B4 B4			
Deluxe		68		85 100 120	160-225 160-225 160-225	5,3 6 6,6		1 1 1	x x x	x x x		x x x		0 0 0		P3 P3 P3	B5 B5 B5		
Twin		70		85 100	200 200	4,6 5,2	x x	1 1			x x		0 0		P1 P1	B5 B5			
Double		72		85 100 120	200 200 200	6,6 7,6 8,7	x x x	1 1 1			x x x		0 0 0		P3 P3 P3	B5 B5 B5			
Extreme		74		150 200	170-270 170-300	9,8 11,6		2 2	x x	x x	x x		2 2	F4 F4	P4 P4	B4 B4			

Selection table

Roll-Banner Cube

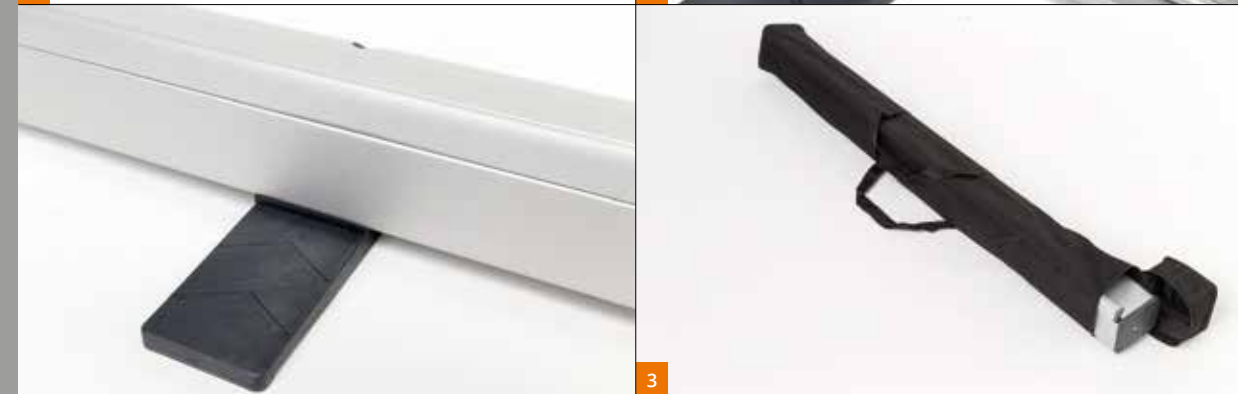
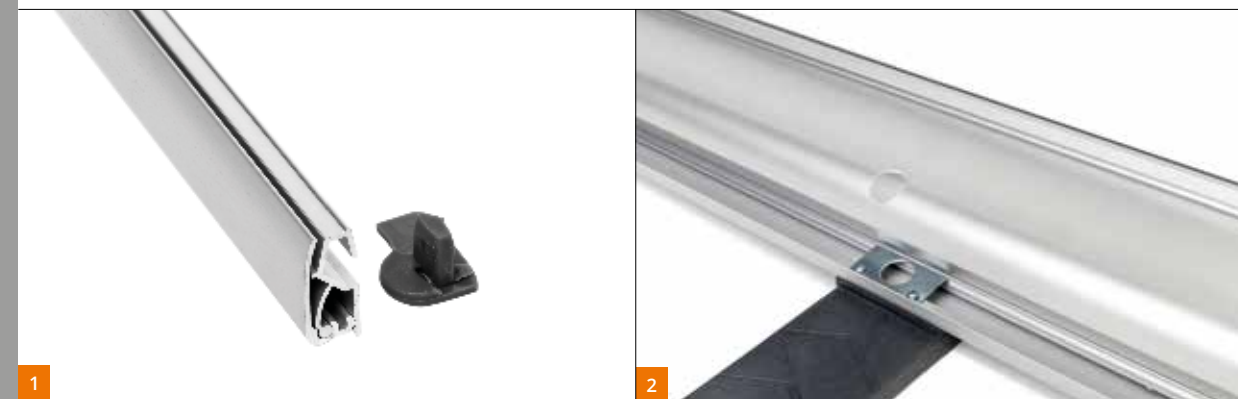

1

2

3



Roll-Banner **Cube**

EN

- Slim and elegant top rail (1)
- Reinforced pole holder (2)
- Stable plastic foot
- Bag with zipper (3)

DE

- Schmales elegantes Oberprofil (1)
- Verstärkte Stangenhalterung (2)
- Stabiler Plastikfuß
- Tasche mit Reißverschluss (3)

NL

- Smal en elegant bovenprofiel (1)
- Versterkte paalhouder (2)
- Stabiele kunststof voet
- Tas met ritssluiting (3)

FR

- Rail au design fin et élégant (1)
- Support-mât renforcé (2)
- Pied en plastique stabilisée
- Sac avec fermeture éclair (3)

ES

- Perfil superior de diseño delgado y elegante (1)
- Soporte para el mástil reforzado (2)
- Pie de plástico estable
- Bolsa con cremallera (3)

! Important:

Single piece cardboard packaging not standard included

Product specifications

Art. nr.	Graphic		Specs		
	W	H	Feet	Poles	KG
RBCUBE060	60	200	1	1	1,6
RBCUBE080	80	200	1	1	1,9
RBCUBE085	85	200	1	1	2
RBCUBE100	100	200	1	1	2,2

All sizes in cm.

Package specifications

Outer box					Pallet capacity	
PCS	W	H	D	KG	Euro	Industrial
9	26	65	26	15,5	324	324
9	26	85	26	18	243	243
9	26	90	26	18,5	243	243
9	26	105	26	20,5	189	189

Order quantity: only per 9 pieces.

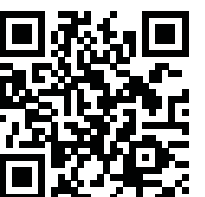

Instructional video

Favourite range

Roll-Banner Budget

- ✔ Lightweight cassette
- ✔ Anodized aluminium feet with black caps
- ✔ Great price-quality ratio

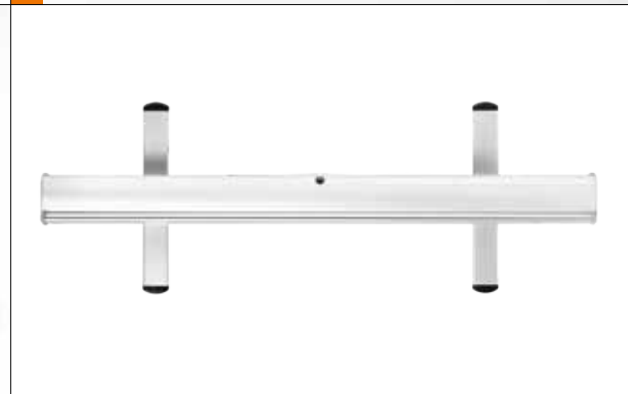

Roll-Banner **Budget**

EN

- Modern top rail (1)
- Rubber button as pole locator (2)
- Aluminium feet with black caps (3)
- Bag with zipper (3)

DE

- Modern Oberprofil (1)
- Gummiknopf als Stangenlocator (2)
- Aluminiumfüße mit schwarzen Kappen (3)
- Tasche mit Reißverschluss (3)

NL

- Modern bovenprofiel (1)
- Rubberen knop als paal locator (2)
- Aluminium voeten met zwarte kapjes (3)
- Tas met ritsluiting (3)

FR

- Rail moderne (1)
- Socle en caoutchouc de maintien du mât (2)
- Pieds en aluminium avec embouts noirs (3)
- Sac avec fermeture éclair (3)

ES

- Perfil superior de diseño moderno (1)
- Botón de goma para localizar el poste (2)
- Pie de aluminio con caperuzas negras (3)
- Bolsa con cremallera (3)

- ✔ Single piece cardboard packaging included

Product specifications

Art. nr.	Graphic		Specs		
	W	H	Feet	Poles	KG
RBB080	80	200	2	1	1,8
RBB085	85	200	2	1	1,9
RBB100	100	200	2	1	2,1

All sizes in cm.

Package specifications

Package	Pallet capacity						
	PCS	W	H	D	KG	Euro	Industrial
8 40 85 20 16,5	8	40	85	20	16,5	208	264
8 40 90 20 17,5	8	40	90	20	17,5	208	264
8 40 105 20 19	8	40	105	20	19	176	216

Order quantity: only per 8 pieces.



Instructional video

Roll-Banner Challenger



1



2



3



4



5



6



Roll-Banner **Challenger**

EN

- Side view of Challenger Alu (1)
- Side view of Challenger Next (2)
- Side view of Challenger Black (3)
- Reinforced pole holder (4)
- Slim and elegant top rail (5)
- Padded bag with zipper over full length (6)

DE

- Seitenansicht des Challenger Alu (1)
- Seitenansicht des Challenger Next (2)
- Seitenansicht des Challenger Black (3)
- Verstärkte Stangenhalterung (4)
- Schmales elegantes Oberprofil (5)
- Verstärkte Tasche mit Innenfutter und Reißverschluss über die ganze Taschenlänge (6)

NL

- Zijaanzicht Challenger Alu (1)
- Zijaanzicht Challenger Next (2)
- Zijaanzicht Challenger Black (3)
- Versterkte paalhouder (4)
- Smal en elegant bovenprofiel (5)
- Tas met verstevigingen en binnenvoering met ritsluiting over volledige lengte (6)

FR

- Vue latérale du Challenger Alu (1)
- Vue latérale du Challenger Next (2)
- Vue latérale du Challenger Black (3)
- Support-mât renforcé (4)
- Rail au design fin et élégant (5)
- Sac renforcé avec doublure et fermeture éclair sur toute la longueur (6)

ES

- Vista lateral del Challenger Alu (1)
- Vista lateral del Challenger Next (2)
- Vista lateral del Challenger Black (3)
- Soporte para el mástil reforzado (4)
- Perfil superior de diseño delgado y elegante (5)
- Bolsa acolchada y reforzada con cremallera a todo el largo (6)

- ✓ Single piece cardboard packaging included

Product specifications

Art. nr.	Colour	Graphic		Specs		
		W	H	Feet	Poles	KG
RBCHA080	●	80	200	2	1	2
RBCHA085	●	85	200	2	1	2,1
RBCHA100	●	100	200	2	1	2,3
RBCHN080	●●	80	200	2	1	2
RBCHN085	●●	85	200	2	1	2,1
RBCHN100	●●	100	200	2	1	2,3
RBCHB085	●●	85	200	2	1	2,1
RBCHB100	●●	100	200	2	1	2,3

All sizes in cm.

Package specifications

PCS	Outer box				Pallet capacity	
	W	H	D	KG	Euro	Industrial
6	37	88	26	14	120	150
6	37	93	26	15	108	132
6	37	108	26	17	96	114
6	37	88	26	14	120	150
6	37	93	26	15	108	132
6	37	108	26	17	96	114
6	37	93	26	15	108	132
6	37	108	26	17	96	114

Order quantity: only per 6 pieces.



Instructional video

Roll-Banner Basic



Roll-Banner **Basic**

EN

- Modern top rail (1)
- Plastic pole locator (2)
- Full aluminium feet
- Padded bag with zipper over full length (3)
- **Optional:** Extension pole (+20 cm height) (4)

DE

- Modern Oberprofil (1)
- Kunststoff-Stangenlocator (2)
- FüÙe komplett aus massivem Aluminium
- Verstärkte Tasche mit Innenfutter und Reißverschluss über die ganze Taschenlänge (3)
- **Optional:** Verlängerungsstange (+20 cm Höhe) (4)

NL

- Modern bovenprofiel (1)
- Kunststof paal locator (2)
- Volledig aluminium voeten
- Tas met verstevigingen en binnenvoering met ritssluiting over volledige lengte (3)
- **Optioneel:** Verlengstuk paal (+20 cm hoogte) (4)

FR

- Rail moderne (1)
- Socle en plastique de maintien du mât (2)
- Pieds en aluminium
- Sac renforcé avec doublure et fermeture éclair sur toute la longueur (3)
- **Optionnel :** Barre d'extension (+20 cm de hauteur) (4)

ES

- Perfil superior de diseño moderno (1)
- Indicador de plástico de posición del poste (2)
- Pies de aluminio
- Bolsa acolchada y reforzada con cremallera a todo el largo (3)
- **Opcional:** Poste de extensión (+20 cm de altura) (4)

Optional extension pole (4)

Art. nr.	Product
P20RBBAS	Lengthening pole (+20 cm height)
P20RBBASB	Lengthening pole (+20 cm height, black)

- ✓ Single piece cardboard packaging included

Product specifications

Art. nr.	Colour	Graphic		Specs		
		W	H	Feet	Poles	KG
RBBAS1F060	●	60	200	1	1	2,3
RBBAS1F080	●	80	200	1	1	2,8
RBBAS1F085	●	85	200	1	1	2,8
RBBAS1F100	●	100	200	1	1	3,2
RBBAS2F080	●	80	200	2	1	2,8
RBBAS2F085	●	85	200	2	1	2,8
RBBAS2F100	●	100	200	2	1	3,2
RBBAS2F120	●	120	200	2	2	3,9
RBBASB085	●	85	200	2	1	2,8
RBBASB100	●	100	200	2	1	3,2

All sizes in cm.

Package specifications

Outer box					Pallet capacity	
PCS	W	H	D	KG	Euro	Industrial
6	37	69	26	15	162	198
6	37	88	26	17	120	150
6	37	93	26	17	108	132
6	37	108	26	20	96	114
6	37	88	26	17	120	150
6	37	93	26	17	108	132
6	37	108	26	20	96	114
4	26	130	26	17	48	48
6	37	93	26	18	108	132
6	37	108	26	20	96	114

Order quantity: only per 6 pieces.



Instructional video

Roll-Banner Plus

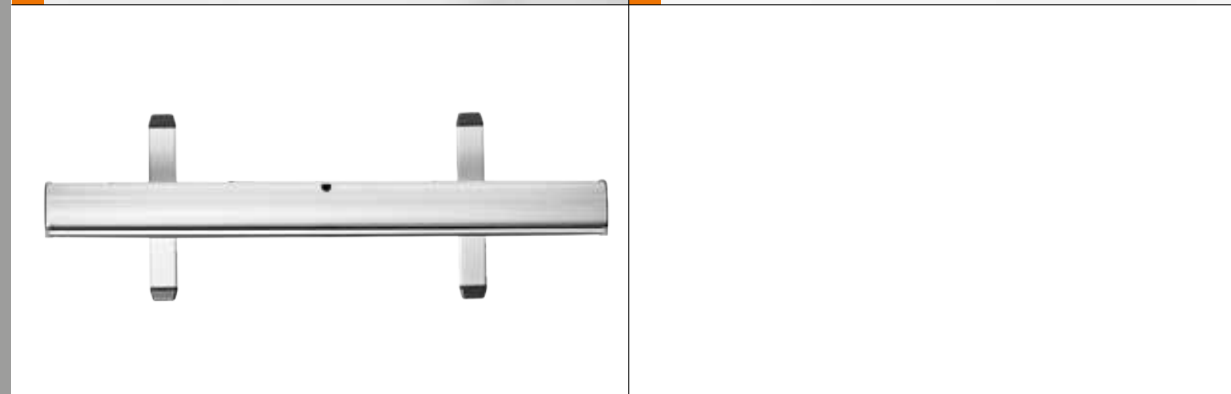
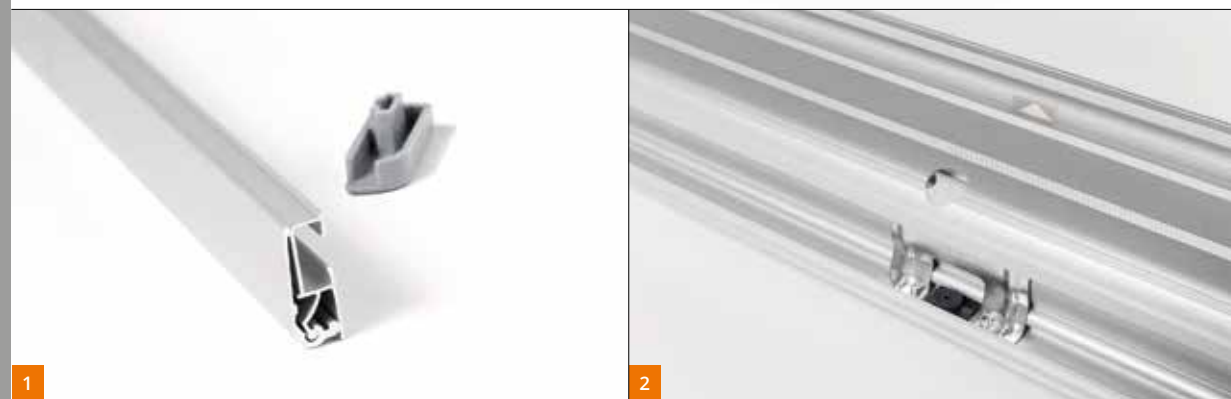

Roll-Banner Plus

EN

- Modern top rail (1)
- Aluminium feet with black caps (2)
- Reinforced pole holder (2)
- Extra long galvanized steel plate on bottom (3)
- Padded bag with braces and zipper (4)

DE

- Modern Oberprofil (1)
- Aluminiumfüße mit schwarzen Kappen (2)
- Verstärkte Stangenhalterung (2)
- Extra lange verzinkte Stahlplatte auf der Unterseite (3)
- Verstärkte Tasche mit Innenfutter und Reißverschluss (4)

NL

- Modern bovenprofiel (1)
- Aluminium voeten met zwarte kapjes (2)
- Versterkte paalhouder (2)
- Extra lange gegalvaniseerde staalplaat op bodem (3)
- Tas met verstevigingen en binnenvoering met ritssluiting (4)

FR

- Rail moderne (1)
- Pieds en aluminium avec embouts noirs (2)
- Support-mât renforcé (2)
- Plateau acier galvanisé extra long au dessous (3)
- Sac renforcé avec doublure et fermeture éclair (4)

ES

- Perfil superior de diseño moderno (1)
- Pie de aluminio con caperuzas negras (2)
- Soporte de mástil reforzado (2)
- Chapa extra larga de acero galvanizado en la parte de abajo (3)
- Bolsa acolchada y reforzada con cremallera (4)

- ✓ Single piece cardboard packaging included

Product specifications

Art. nr.	Graphic		Specs			
	W	H	Feet	Poles	KG	Steel plate
RBPL040	40	200	1	1	1,6	5
RBPL060	60	200	2	1	2,2	37
RBPL080	80	200	2	1	2,2	52
RBPL085	85	200	2	1	2,8	57
RBPL100	100	200	2	1	3,2	72
RBPL120*	120	200	2	2	4,1	92
RBPL150*	150	200	2	2	4,8	122

All sizes in cm.

Package specifications

Outer box					Pallet capacity	
PCS	W	H	D	KG	Euro	Industrial
6	37	69	26	12	162	198
6	37	69	26	15	162	198
6	37	88	26	19	120	150
6	37	93	26	20	108	132
6	37	108	26	22	96	114
4	26	128	26	20	48	48
4	26	158	26	24	48	48

Order quantity: only per 6 / *4 pieces.



Instructional video

Favourite range

Roll-Banner Triangle

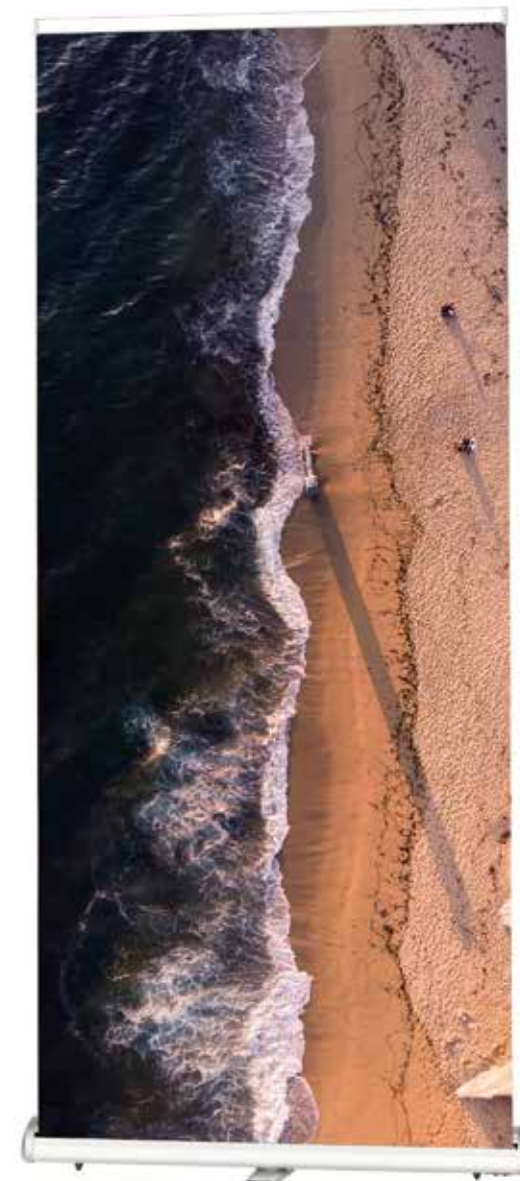
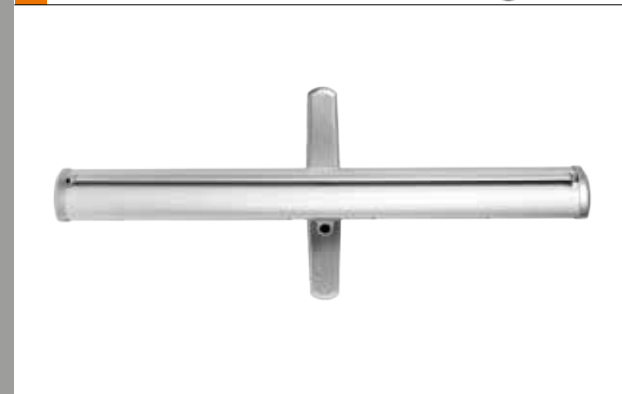

Roll-Banner Triangle

EN

- Modern top rail (1)
- Telescopic pole
- Powder coated steel foot with anti-slip pads (2)
- Padded bag with zipper over full length (3)
- Patented fixation for optimal banner angle (4)

DE

- Modern Oberprofil (1)
- Teleskopstange
- Pulverbeschichtete Stahlfüße mit Anti-Rutschbelägen (2)
- Verstärkte Tasche mit Innenfutter und Reißverschluss über die ganze Taschenlänge (3)
- Patentierte Fixierung für optimale Stabilität (4)

NL

- Modern bovenprofiel (1)
- Telescopische paal
- Gepoedercoate stalen voet met anti-slip pads (2)
- Tas met verstevigingen, binnenvoering en ritsluiting over volledige lengte (3)
- Gepatenteerde fixering voor optimale stabiliteit (4)

FR

- Rail moderne (1)
- Mât télescopique
- Pied en acier revêtement peinture poudrée avec patins antidérapants (2)
- Sac renforcé avec doublure et fermeture éclair sur toute la longueur (3)
- Système de fixation breveté pour une stabilité optimale (4)

ES

- Perfil superior de diseño moderno (1)
- Mástil telescópico
- Pie de acero lacado en mate con fondo anti-resbalo (2)
- Bolsa acolchada y reforzada con cremallera a todo el largo (3)
- Sistema de enganche patentado para una estabilidad óptima (4)

- ✓ Single piece cardboard packaging included

Product specifications

Art. nr.	Graphic		Specs		
	W	H	Feet	Poles	KG
RBTR085	85	160 - 220	1	1	3,5
RBTR100	100	160 - 220	1	1	3,8
RBTR120*	120	160 - 220	2	2	5,2
RBTR150*	150	160 - 220	2	2	6,1

All sizes in cm.

Package specifications

Outer box					Pallet capacity	
PCS	W	H	D	KG	Euro	Industrial
6	39	99	30	22	96	120
6	39	113	30	25	84	90
4	29	133	27	13	48	48
2	26	163	16	13	48	48

Order quantity: only per 6 / *4 / *2 pieces.



Instructional video

Roll-Banner Evolution

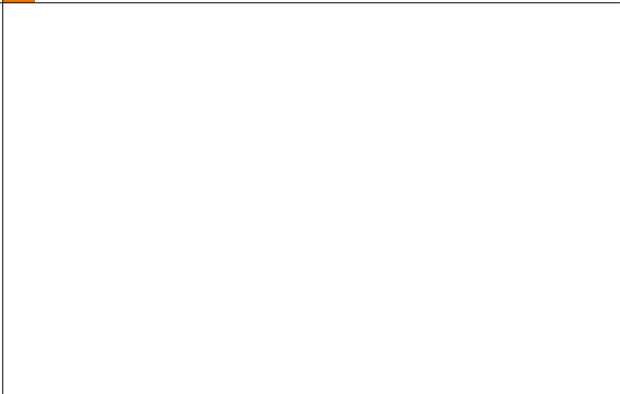
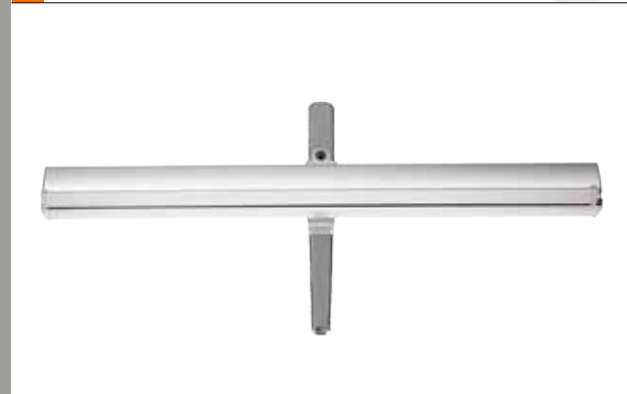

Roll-Banner Evolution

EN

- Cassette with chromed side caps and chromed steel foot
- Heavy duty top rail (1)
- Telescopic pole (2)
- Padded bag with zipper over full length (3)

DE

- Kassette mit verchromten Seitenkappen und verchromter Stahlfuß
- Robustes Oberprofil (1)
- Teleskopstange (2)
- Verstärkte Tasche mit Innenfutter und Reißverschluss über die ganze Taschenlänge (3)

NL

- Cassette met verchromde zijkant en verchromde stalen voet
- Robuust bovenprofiel (1)
- Telescopische paal (2)
- Tas met verstevigingen en binnenvoering met ritssluiting over volledige lengte (3)

FR

- Cassette avec côtés chromés et pied en acier chromés
- Rail robuste (1)
- Mât télescopique (2)
- Sac renforcé avec doublure et fermeture éclair sur toute la longueur (3)

FR

- carcasa con laterales cromados y pie de acero cromado
- Perfil superior robusto (1)
- Mástil telescópico (2)
- Bolsa acolchada y reforzada con cremallera a todo el largo (3)

- ✓ Single piece cardboard packaging included

Product specifications

Art. nr.	Graphic		Specs		
	W	H	Feet	Poles	KG
RBEVO085	85	160 - 220	1	1	3,6
RBEVO100	100	160 - 220	1	1	4,1
RBEVO120*	120	160 - 220	2	1	4,9
RBEVO150*	150	160 - 220	2	2	6

All sizes in cm.

Package specifications

Outer box					Pallet capacity	
PCS	W	H	D	KG	Euro	Industrial
6	41	97	29	25	96	108
4	41	112	29	27	84	96
4	29	132	29	23	48	48
2	28	160	15	15	46	48

Order quantity: only per 6 / *4 / *2 pieces.



Instructional video

Favourite range

Roll-Banner Delight

NEW

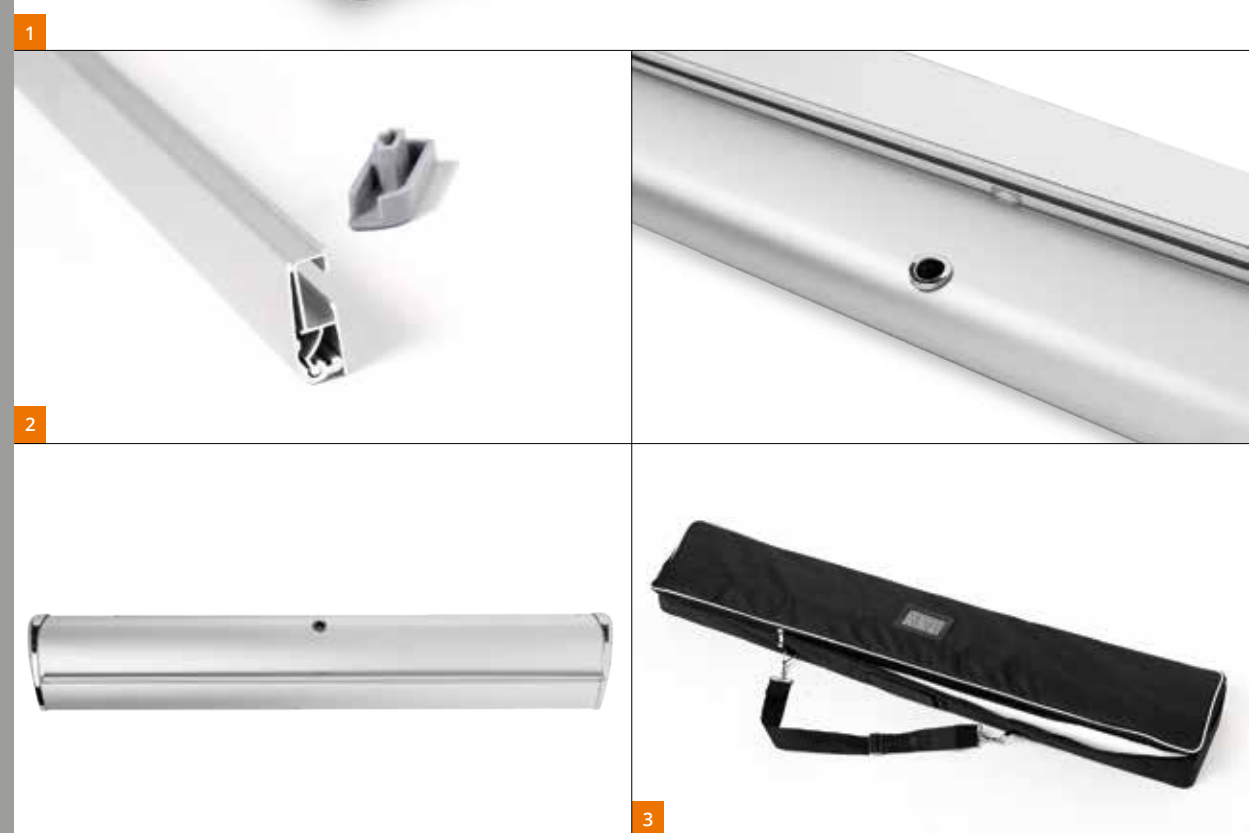

1

2

3

- ✓ Exclusive look
- ✓ Elegant cassette with chromed side caps
- ✓ Premium banner for a budget price

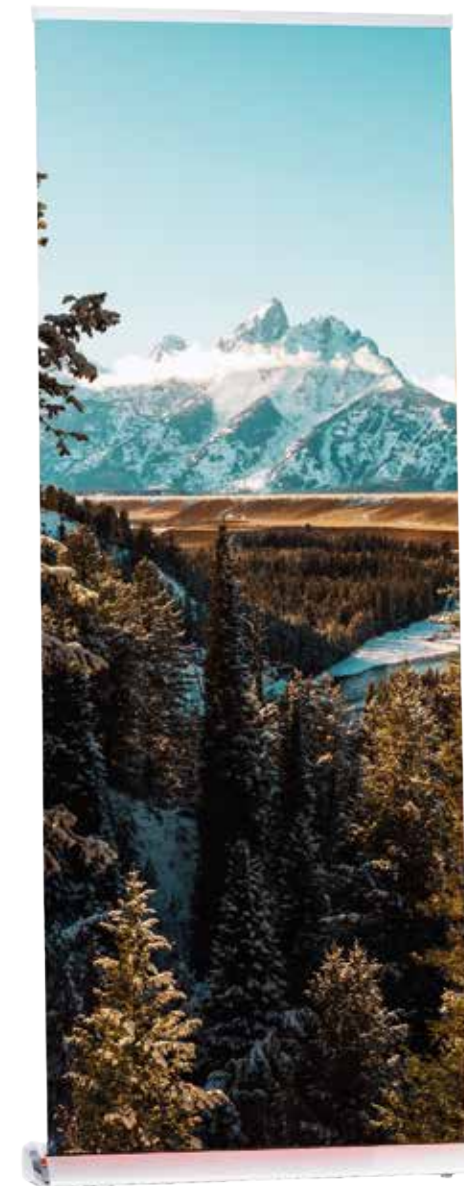

Roll-Banner **Delight**

EN

- Cassette with chromed side caps (1)
- Modern top rail (2)
- Levelling screws on bottom side
- Padded bag with zipper over full length (3)

DE

- Kassette mit verchromten Seitenkappen (1)
- Modern Oberprofil (2)
- Stellfüße an der Unterseite
- Verstärkte Tasche mit Innenfutter und Reißverschluss über die ganze Taschenlänge (3)

NL

- Cassette met verchromde zijkant (1)
- Modern bovenprofiel (2)
- Stelvoeten aan onderzijde
- Tas met verstevigingen en binnenvoering met ritssluiting over volledige lengte (3)

FR

- Cassette avec côtés chromés (1)
- Rail moderne (2)
- Pieds réglables
- Sac renforcé avec doublure et fermeture éclair sur toute la longueur (3)

ES

- Carcasa con laterales cromados (1)
- Perfil superior de diseño moderno (2)
- Pies regulables
- Bolsa acolchada y reforzada con cremallera a todo el largo (3)

- ✓ Single piece cardboard packaging included

Product specifications

Art. nr.	Graphic		Specs	
	W	H	Poles	KG
RBDL085	85	200	1	4,2

All sizes in cm.

Package specifications

Outer box					Pallet capacity	
PCS	W	H	D	KG	Euro	Industrial
4	47	98	25	17,8	56	72

Order quantity: only per 4 pieces.



Instructional video

Roll-Banner Premium

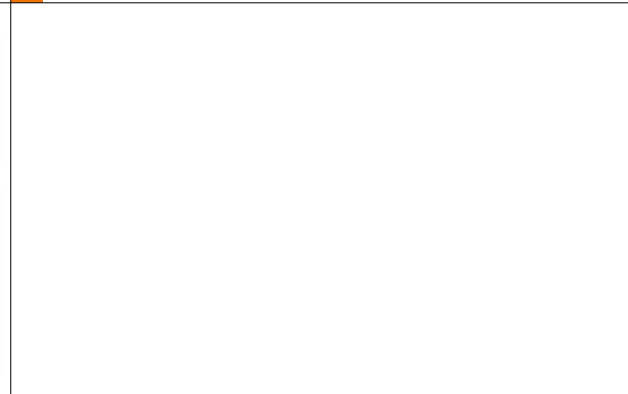

Roll-Banner Premium

EN

- Cassette with chromed side caps
- Heavy duty top rail (1)
- Telescopic pole (2)
- Levelling screws on bottom side
- Padded bag with zipper over full length (3)

DE

- Kassette mit verchromten Seitenkappen
- Robustes Oberprofil (1)
- Teleskopstange (2)
- Stellfüße an der Unterseite
- Verstärkte Tasche mit Innenfutter und Reißverschluss über die ganze Taschenlänge (3)

NL

- Cassette met verchromde zijkant
- Robuust bovenprofiel (1)
- Telescopische paal (2)
- Stelvoeten aan onderzijde
- Tas met verstevigingen en binnenvoering met ritsluiting over volledige lengte (3)

FR

- Cassette avec côtés chromés
- Rail robuste (1)
- Mât télescopique (2)
- Pieds réglables
- Sac renforcé avec doublure et fermeture éclair sur toute la longueur (3)

ES

- Carcasa con laterales cromados
- Perfil superior robusto (1)
- Mástil telescópico (2)
- Pies regulables
- Bolsa acolchada y reforzada con cremallera a todo el largo (3)

- ✓ Single piece cardboard packaging included

Product specifications

Art. nr.	Colour	Graphic		Specs	
		W	H	Poles	KG
RBP085	●	85	160-220	1	5,7
RBP100	●	100	160-220	1	6,8
RBP120*	●	120	160-220	1	8,3
RBP150*	●	150	160-220	2	10
RBPB085	●	85	160-220	1	5,7
RBPB100	●	100	160-220	1	6,8

All sizes in cm.

Package specifications

Outer box					Pallet capacity	
PCS	W	H	D	KG	Euro	Industrial
4	44	98	24	26	56	80
4	44	114	24	29	52	72
2	22	136	24	18	30	40
2	22	164	24	21	30	40
4	44	98	24	26	56	80
4	44	114	24	29	52	72

Order quantity: only per 4 / *2 pieces.



Instructional video

Roll-Banner Massive

- ✓ Robust and highly stable
- ✓ Height adjustable
- ✓ Incredibly durable

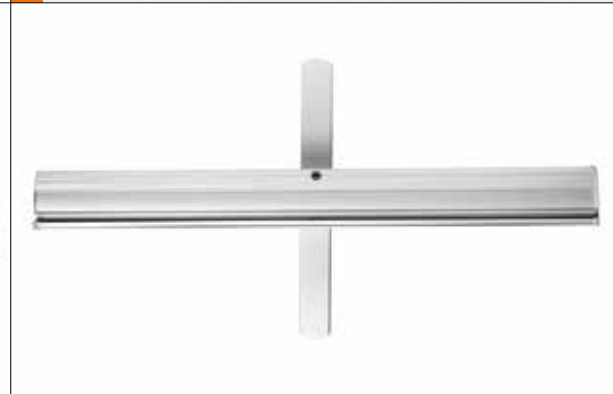

- ✓ Single piece cardboard packaging included

Roll-Banner **Massive**

EN

- Heavy duty top rail (1)
- Telescopic pole (2)
- Massive aluminium foot (3)
- Padded bag with zipper over full length (4)

DE

- Robustes Oberprofil (1)
- Teleskopstange (2)
- Massiver Aluminiumfuß (3)
- Verstärkte Tasche mit Innenfutter und Reißverschluss über die ganze Taschenlänge (4)

NL

- Robuust bovenprofiel (1)
- Telescopische paal (2)
- Massieve aluminium voet (3)
- Tas met verstevigingen en binnenvoering met ritssluiting over volledige lengte (4)

FR

- Rail robuste (1)
- Mât télescopique (2)
- Pieds en aluminium massif (3)
- Sac renforcé avec doublure et fermeture éclair sur toute la longueur (4)

ES

- Perfil superior robusto (1)
- Mástil telescópico (2)
- Ries de aluminio masivo (3)
- Bolsa acolchada y reforzada con cremallera a todo el largo (4)

Product specifications

Art. nr.	Graphic		Specs		
	W	H	Feet	Poles	KG
RBMA085	85	160 - 220	1	1	4,1
RBMA100	100	160 - 220	1	1	5
RBMA120*	120	160 - 220	2	1	6,3
RBMA150*	150	160 - 220	2	2	7,6

All sizes in cm.

Package specifications

Outer box					Pallet capacity	
PCS	W	H	D	KG	Euro	Industrial
6	39	97	29	28	96	108
4	39	110	29	22	84	90
4	26	130	29	26	48	48
2	15	160	29	18	40	48

Order quantity: only per 6 / *4 / *2 pieces.



Instructional video

Roll-Banner Deluxe



Roll-Banner **Deluxe**

EN

- Cassette with chromed side caps
- Heavy duty top rail (1)
- Adjustable telescopic pole with height indication (2)
- Bottom snap rail with adjustable spring tension (3)
- Padded bag with zipper over full length (4)

DE

- Kassette mit verchromten Seitenkappen
- Robustes Oberprofil (1)
- Verstellbare Teleskopstange mit Höhenangabe (2)
- Untere Klemmschiene mit einstellbarer Federspannung (3)
- Verstärkte Tasche mit Innenfutter und Reißverschluss über die ganze Taschenlänge (4)

NL

- Cassette met verchromde zijkant
- Robuust bovenprofiel (1)
- Verstelbare telescopische paal met hoogteaanwijzing (2)
- Onderzijde klemprofiel met verstelbare veerspanning (3)
- Tas met verstevigingen en binnenvoering met ritssluiting over volledige lengte (4)

FR

- Cassette avec côtés chromés
- Rail robuste (1)
- Mât télescopique ajustable avec indication de la hauteur (2)
- Rail inférieur à clip avec tension à ressort ajustable (3)
- Sac renforcé avec doublure et fermeture éclair sur toute la longueur (4)

ES

- Carcasa con laterales cromados
- Perfil superior robusto (1)
- Poste telescópico con indicación de altura (2)
- Perfil de sujeción inferior con ressort ajustable (3)
- Bolsa acolchada y reforzada con cremallera a todo el largo (4)

- ✓ Single piece cardboard packaging included

Product specifications

Art. nr.	Graphic		Specs	
	W	H	Poles	KG
RBL085	85	160-225	1	5,3
RBL100	100	160-225	1	6
RBL120*	120	160-225	1	6,6

All sizes in cm.

Package specifications

Outer box					Pallet capacity	
W	H	D	KG	PCS	Euro	Industrial
36	99	29	19	3	48	66
36	113	29	21	3	42	48
27	135	25	18	2	24	32

Order quantity: only per 3 / *2 pieces.



Instructional video

Roll-Banner Twin

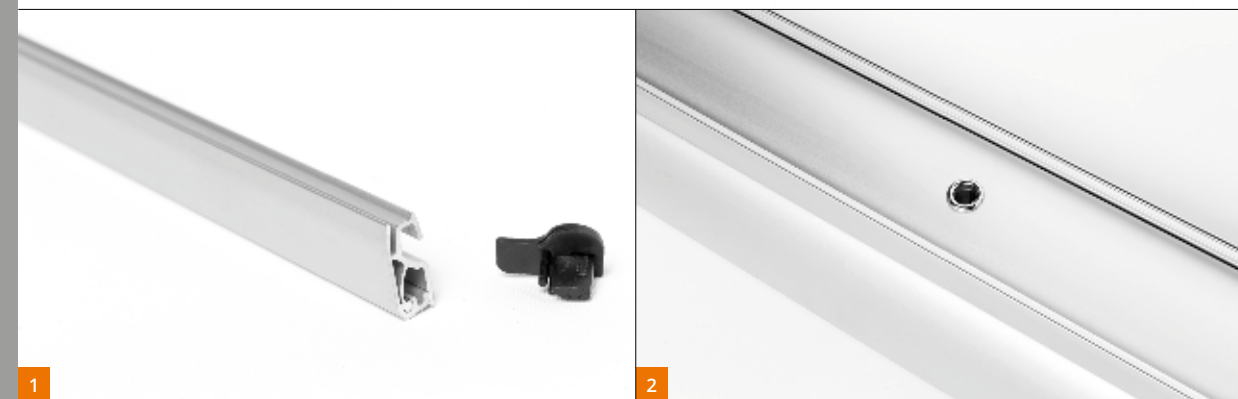

1

2

3



Roll-Banner **Twin**

EN

- Slim and elegant top rail (1)
- Pole locator, hidden between two prints (2)
- Padded bag with zipper over full length (3)

DE

- Schmales elegantes Oberprofil (1)
- Stangenlocator, verborgen zwischen zwei Prints (2)
- Verstärkte Tasche mit Innenfutter und Reißverschluss über die ganze Taschenlänge (3)

NL

- Smal en elegant bovenprofiel (1)
- Paal locator verborgen tussen twee prints (2)
- Tas met verstevigingen en binnenvoering met ritssluiting over volledige lengte (3)

FR

- Rail au design fin et élégant (1)
- Socle de maintien du mât caché entre 2 imprimés (2)
- Sac renforcé avec doublure et fermeture éclair sur toute la longueur (3)

ES

- Perfil superior de diseño delgado y elegante (1)
- Indicador de posición del mástil oculto entre dos impresiones (2)
- Bolsa acolchada y reforzada con cremallera a todo el largo (3)

- ✓ Single piece cardboard packaging included

Product specifications

Art. nr.	Graphic		Specs	
	W	H	Poles	KG
RBTW085	85	200	1	4,6
RBTW100	100	200	1	5,2

All sizes in cm.

Package specifications

Outer box					Pallet capacity	
PCS	W	H	D	KG	Euro	Industrial
4	47	99	25	20	56	72
4	47	114	25	22	52	68

Order quantity: only per 4 pieces.



Instructional video

Roll-Banner Double

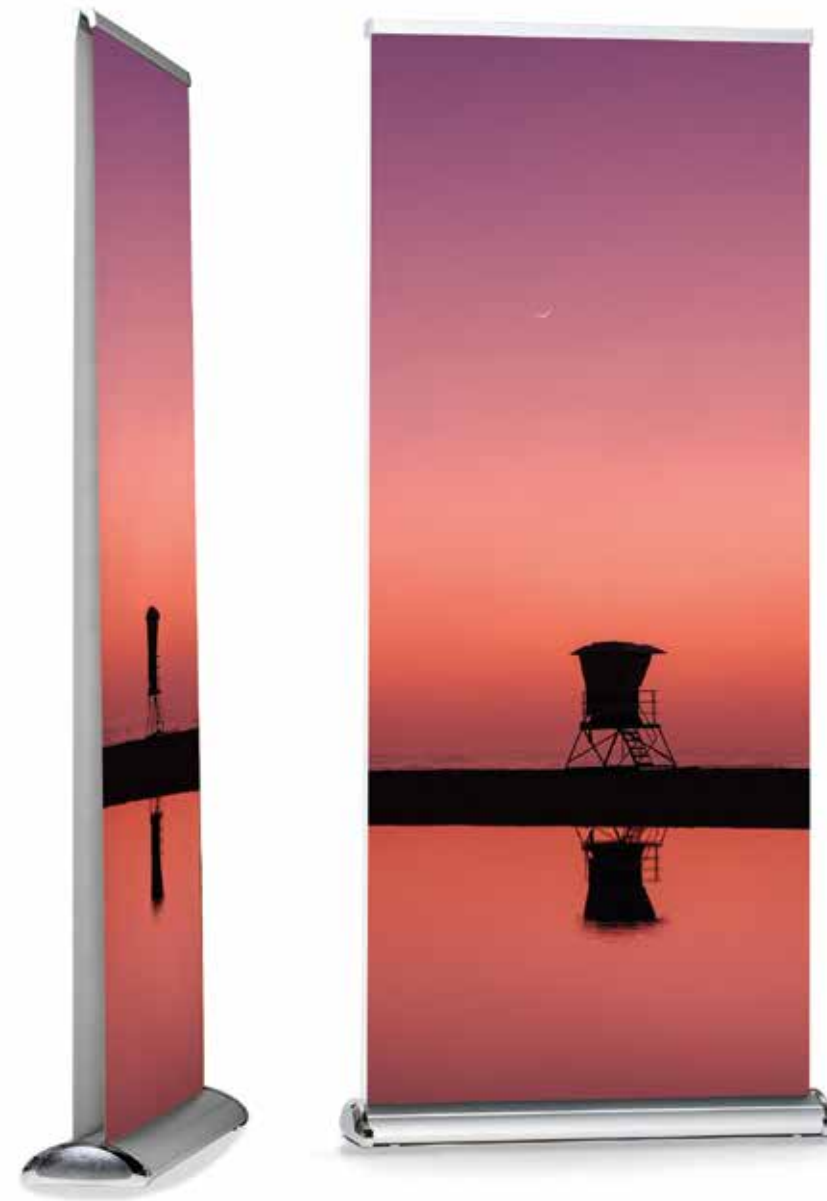
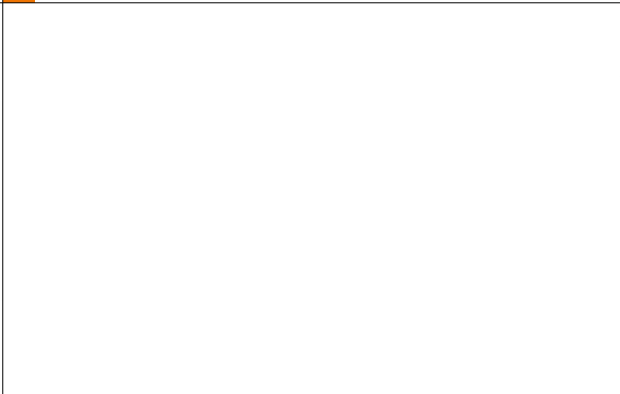
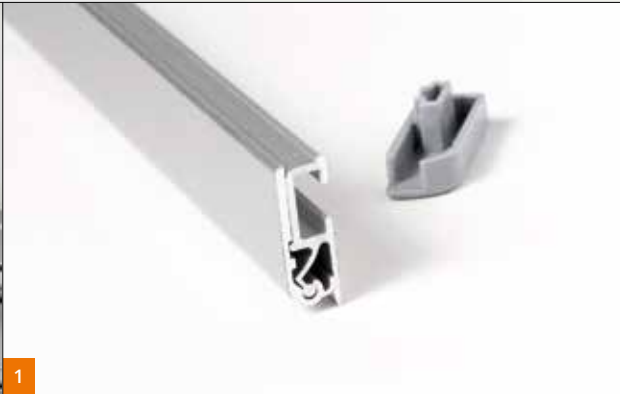

Roll-Banner **Double**

EN

- Cassette with chromed side caps
- Modern and heavy duty top rail (1)
- Minimised graphic distance (2)
- Padded bag with zipper over full length (3)

DE

- Kassette mit verchromten Seitenkappen
- Modernes und robustes Oberprofil (1)
- Minimaler Grafikabstand (2)
- Verstärkte Tasche mit Innenfutter und Reißverschluss über die ganze Taschenlänge (3)

NL

- Cassette met verchromde zijkant
- Modern en robuust bovenprofiel (1)
- Minimale afstand tussen prints (2)
- Tas met verstevigingen en binnenvoering met ritssluiting over volledige lengte (3)

FR

- Cassette avec côtés chromés
- Rail moderne et robuste (1)
- Distance minime entre les visuels (2)
- Sac renforcé avec doublure et fermeture éclair sur toute la longueur (3)

ES

- Carcasa con laterales cromados
- Perfil superior robusto y moderno (1)
- Distancia mínima entre los visuales (2)
- Bolsa acolchada y reforzada con cremallera a todo el largo (3)

- ✓ Single piece cardboard packaging included

Product specifications

Art. nr.	Graphic		Specs	
	W	H	Poles	KG
RBD085	85	200	1	6,6
RBD100	100	200	1	7,6
RBD120*	120	200	1	8,7

All sizes in cm.

Package specifications

Outer box	Pallet capacity				
	PCS	W	H	D	KG
3	36	99	29	24	48
3	36	113	29	28	42
2	27	135	25	22	24

Order quantity: only per 3 / *2 pieces.

Pallet capacity

Euro	Industrial
48	60
42	51
24	32



Instructional video

Roll-Banner Extreme



1: Patented



2



3



4



Roll-Banner **Extreme**

EN

- Solid patented aluminium side caps (1)
- Top rail with clamping screws (2)
- Adjustable telescopic poles with height indication (3)
- Padded bag with zipper over full length (4)

DE

- Massive patentierte Aluminiumseitenkappen (1)
- Oberprofil mit Klemverschraubung (2)
- Verstellbare Teleskopstangen mit Höhenangabe (3)
- Verstärkte Tasche mit Innenfutter und Reißverschluss über die ganze Taschenlänge (4)

NL

- Massieve gepatenteerde aluminium zijkappen (1)
- Bovenprofiel met klem Schroeven (2)
- Verstelbare telescopische palen met hoogteaanduiding (3)
- Tas met verstevigingen en binnenvoering met ritssluiting over volledige lengte (4)

FR

- Côtes robustes d'aluminium brevetés (1)
- Rail avec vis à pince (2)
- Mâts télescopiques avec indicateur de la hauteur (3)
- Sac renforcé avec doublure et fermeture éclair sur toute la longueur (4)

ES

- Tapas de aluminio sólido patentados (1)
- Perfil superior con tornillos de apriete (2)
- Postes telescópicos con indicación de altura (3)
- Bolsa acolchada y reforzada con cremallera a todo el largo (4)

- ✓ Single piece cardboard packaging included

Product specifications

Art. nr.	Graphic		Specs		
	W	H	Feet	Poles	KG
RBEX150	150	170-270	2	2	9,8
RBEX200	200	170-300	2	2	11,6

All sizes in cm.

Package specifications

Outer box	PCS	W	H	D	KG	Pallet capacity	
						Euro	Industrial
	2	33	162	18	21	28*	36*
	1	18	210	15	13	30*	36*

No minimum order quantity.

*Transport options in consultation



Instructional video

Roll-Banner Mini

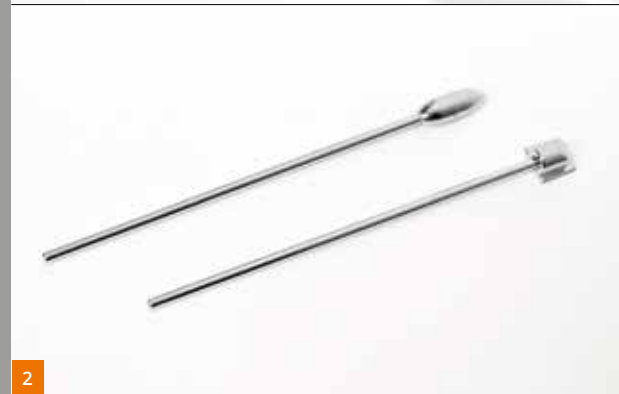

Roll-Banner **Mini**

EN

- Cassette with chromed side caps
- Top rail with TESA adhesive tape (1)
- Chromed steel pole (2)
- Single piece cardboard packaging (3)

DE

- Kasette mit verchromten Seitenkappen
- Oberprofil mit doppelseitigem TESA Klebeband (1)
- Verchromte Stahlstange (2)
- In Einzelkartonagen verpackt (3)

NL

- Cassette met verchromde zijkant
- Bovenprofiel met zelfklevende TESA tape (1)
- Verchromde stalen paal (2)
- Individuele kartonnen verpakking (3)

FR

- Cassette avec côtés chromés
- Rail supérieur avec adhésif TESA (1)
- Perche chromée en acier (2)
- Emballage carton individuel par pièce (3)

ES

- Carcasa con laterales cromados
- Perfil superior con cinta autoadhesiva TESA (1)
- Barra de acero cromado (2)
- Envase en cartón individual (3)

- ✓ Single piece cardboard packaging included

Product specifications

Art. nr.	Graphic		Specs	
	W	H	Poles	KG
RBMA4	21	29,7	1	0,3
RBMA3	29,7	42	1	0,4

All sizes in cm.

Package specifications

Outer box	Pallet capacity				
	PCS	W	H	D	KG
10	27	21	26	4	1080
10	37	21	26	5	1360

Order quantity: only per 10 pieces.

Pallet capacity

Euro	Industrial
1080	1360
810	1020



Instructional video

Banner Stands

L-Banner Quick	80
L-Banner Telescopic	82
X-Banner Budget	84
X-Banner Premium	86

L-Banner Quick



1

2

3

4

5: Optional

- Minimalist design
- Quick and easy change of prints
- System barely visible



L-Banner Quick

EN

- Twist foot with screw connection (1)
- Bottom pole holder (2)
- Snap rail on top and bottom (3)
- Basic transporter bag (4)
- Optional:** Cardboard tube for protection prints (5)

DE

- Drehfuß mit Schraubanschluß (1)
- Stangenhalterung unten (2)
- Oben und unten Klemmschiene (3)
- Einfache Transporttasche (4)
- Optional:** Papprolle zum Schutz der Drucke (5)

NL

- Draaivoet met schroefverbinding (1)
- Onderkant paalhouder (2)
- Klemprofiel boven en onder (3)
- Simpele transporttas (4)
- Optioneel:** Kartonnen koker voor bescherming prints (5)

FR

- Pied pivotable vissé (1)
- Support mât inférieur (2)
- Rail à clips en bas et en haut (3)
- Sac de transport basique (4)
- Optionnel :** Tube de rangement en carton afin de protéger les visuels (5)

ES

- Pie giratorio con conexión roscada (1)
- Soporte de poste inferior (2)
- Perfil abatible superior e inferior (3)
- Bolsa de transporte básica (4)
- Optional:** Tubo de cartón para la protección de los visuales (5)

Optional cardboard tube (5)

Art. nr.	Product
BT080	Banner Tube 80 cm
BT100	Banner Tube 100 cm

Important:
Single piece cardboard packaging not standard included

Product specifications

Art. nr.	Dimensions		
	W	H	KG
LBQ080	80	200	1,3
LBQ100	100	200	1,5

All sizes in cm.

Package specifications

Outer box				
PCS	W	H	D	KG
15	26	87	27	21
15	26	103	27	24

Order quantity: only per 15 pieces.

Pallet capacity

Euro	Industrial
360	405
240	360



L-Banner Telescopic

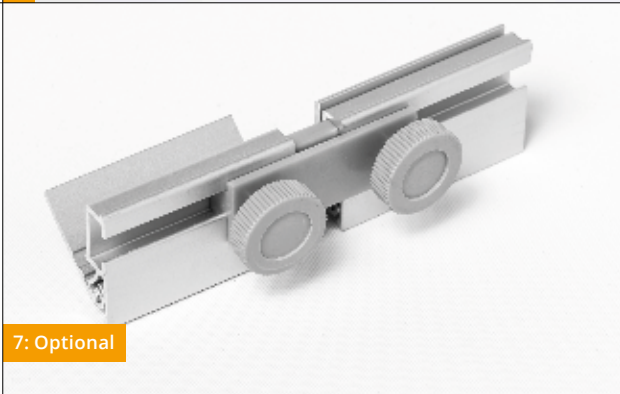

6: Optional

7: Optional



L-Banner Telescopic

EN

- Luxurious massive aluminium foot (1)
- Snap rail on top and bottom (2)
- Telescopic pole (3)
- Heavy duty snap rail on top and bottom (4)
- 3 compartment tube bag (5)
- **Optional:** Cardboard tube for protection prints (6)
- **Optional:** L-Banner connector (7)

DE

- Formschöner massiver Aluminiumfuß (1)
- Oben und unten Klemmschiene (2)
- Teleskopstange (3)
- Robuste Klemmschiene, oben und unten (4)
- Köchertasche mit 3 Fächern (5)
- **Optional:** Papprolle zum Schutz der Drucke (6)
- **Optional:** L-Banner connector (7)

NL

- Luxe massieve aluminium voet (1)
- Klemprofiel boven en onder (2)
- Telescopische paal (3)
- Robuust klemprofiel boven en onder (4)
- 3 compartimenten kokertas (5)
- **Optioneel:** Kartonnen koker voor bescherming prints (6)
- **Optioneel:** L-Banner connector (7)

FR

- Pied design luxueux et massif en aluminium (1)
- Rail à clips en haut et en bas (2)
- Mât télescopique (3)
- Rail à clips robuste en haut et en bas (4)
- Sac pour le tube doté de 3 compartiments (5)
- **Optionnel :** Tube de rangement en carton afin de protéger les visuels (6)
- **Optionnel :** L-Banner connector (7)

ES

- Pie lujoso y masivo en aluminio (1)
- Perfil abatible superior e inferior (2)
- mástil telescópico (3)
- Perfil robusto abatible en la parte superior e inferior (4)
- Bolsa tubular con 3 compartimentos (5)
- **Opcional:** Tubo de cartón para la protección de los visuales (6)
- **Opcional:** L-Banner connector (7)

! Important:

Single piece cardboard packaging not standard included

Optional cardboard tube (6)

Art. nr.	Product
BT080	Banner Tube 80 cm
BT085	Banner Tube 85 cm
BT100	Banner Tube 100 cm

Optional connector (7)

Art. nr.	Product
LBC	L-Banner Connector

Product specifications

Art. nr.	Dimensions		
	W	H	KG
LB080	80	160-220	2,4
LB085	85	160-220	2,5
LB100	100	160-220	2,7

All sizes in cm.

Package specifications

Art. nr.	Outer box				
	PCS	W	H	D	KG
LB080	10	35	90	37	25
LB085	10	35	95	37	26
LB100	10	35	110	37	29

Order quantity: only per 10 pieces.

Pallet capacity

Euro	Industrial
120	120
120	120
100	100

80



Instructional video

X-Banner Budget

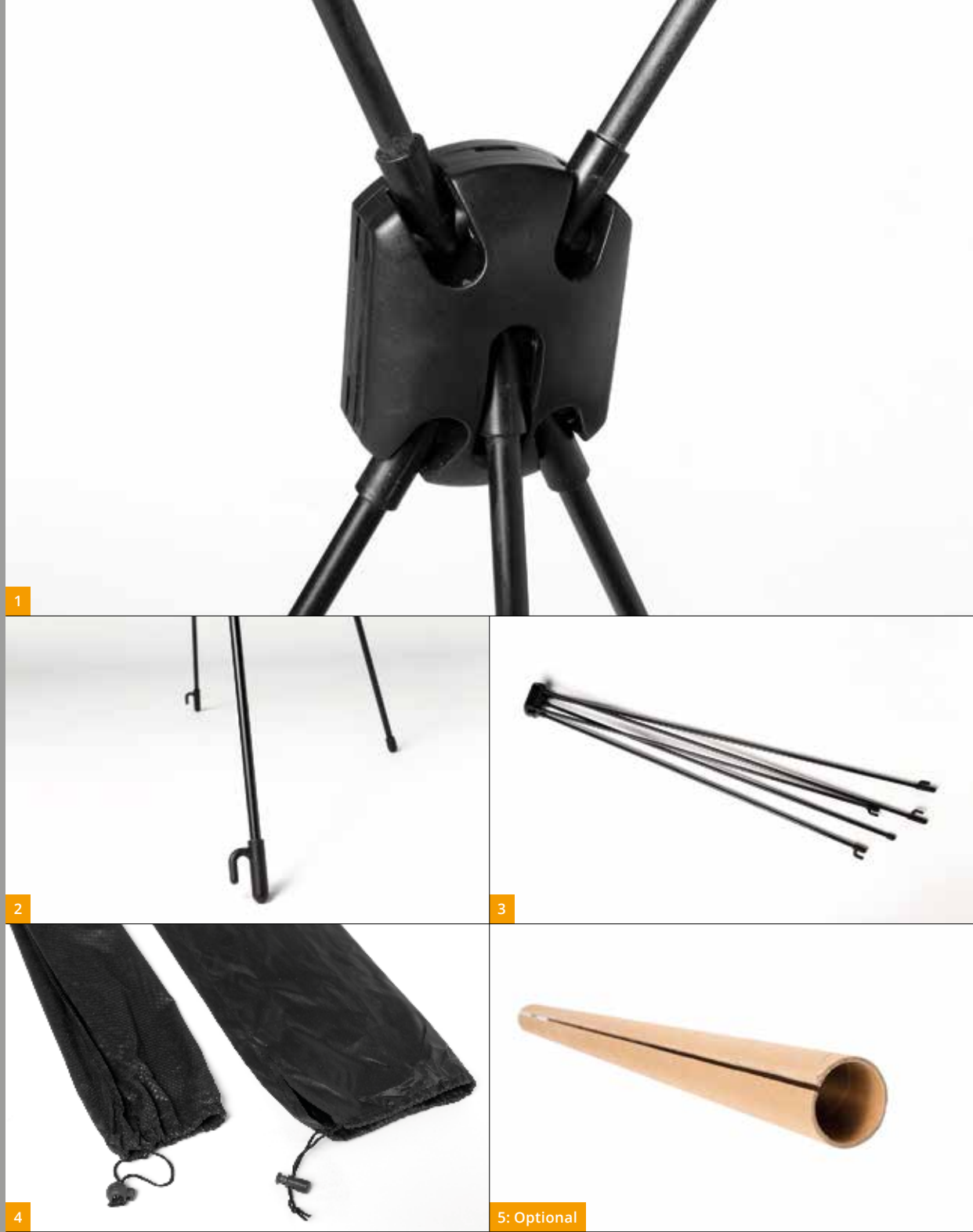

1

2

4

3

5: Optional



X-Banner Budget

EN

- Center connector (1)
- Low position bottom hook (2)
- Compact storage (3)
- Protection pouch included (left), transporter bag is optional (right) (4)
- **Optional:** Cardboard tube for protection prints (5)

DE

- Zentraler Verbindungspunkt (1)
- Niedrig positionierter Haken unten (2)
- Kompakt zu lagern (3)
- Schutztasche inklusive (links), Transporttasche ist optional (rechts) (4)
- **Optional:** Papprolle zum Schutz der Drucke (5)

NL

- Centraal verbindingpunt (1)
- Laag gepositioneerde onderhaak (2)
- Compact op te bergen (3)
- Inclusief beschermende hoes (links), transporttas is optioneel (rechts) (4)
- **Optioneel:** Kartonnen koker voor bescherming prints (5)

FR

- Connecteur central (1)
- Crochets en position basse (2)
- Rangement compact (3)
- Sac de protection inclus (à gauche), sac de transport en option (à droite) (4)
- **Optionnel :** Tube de rangement en carton afin de protéger les visuels (5)

ES

- Conector central (1)
- Gancho inferior (2)
- Almacenaje compacto (3)
- Funda de protección incluida (izquierda), la bolsa de transporte es opcional (derecha) (4)
- **Opcional:** Tubo de cartón para la protección de los visuales (5)

! Important:

Single piece cardboard packaging not standard included

Optional cardboard tube (5)

Art. nr.	Product
BT060	Banner Tube 60 cm
BT080	Banner Tube 80 cm

Product specifications

Art. nr.	Dimensions		
	W	H	KG
XBB60-160	60	160	0,35
XBB80-180	80	180	0,35
XBB80-200	80	200	0,35

All sizes in cm.

Package specifications

Outer box				
PCS	W	H	D	KG
40	30	96	40	16
40	30	106	40	16
40	30	116	40	16

Order quantity: only per 40 pieces.

Pallet capacity

Euro	Industrial
480	400
400	400
400	400



Instructional video

X-Banner Premium



4: Optional

1

2

3



X-Banner Premium

EN

- Aluminium tripod with fiber tops
- Center connector (1)
- Low position bottom hook (2)
- Transporter bag (3)
- **Optional:** Cardboard tube for protection prints (4)

DE

- Aluminium-Stativ mit Fiberglasstangen oben
- Zentraler Verbindungspunkt (1)
- Niedrig positionierter Haken unten (2)
- Transporttasche (3)
- **Optional:** Papprolle zum Schutz der Drucke (4)

NL

- Aluminium driepoot met fiberglas toppalen
- Centraal verbindingpunt (1)
- Laag gepositioneerde onderhaak (2)
- Transporttas (3)
- **Optioneel:** Kartonnen koker voor bescherming prints (4)

FR

- Trépied aluminium avec mâts supérieurs en fibre de verre
- Connecteur central (1)
- Crochets en position basse (2)
- Sac pour transport (3)
- **Optionnel :** Tube de rangement en carton afin de protéger les visuels (4)

ES

- Trípode de aluminio con tapas superiores de fibra de vidrio
- Conector central (1)
- Gancho inferior (2)
- Bolsa de transporte (3)
- **Opcional:** Tubo de cartón para la protección de los visuales (4)

Optional cardboard tube (4)

Art. nr.	Product
BT060	Banner Tube 60 cm
BT080	Banner Tube 80 cm
BT100	Banner Tube 100 cm
BT120	Banner Tube 120 cm

! Important:

Single piece cardboard packaging not standard included

Product specifications

Art. nr.	Dimensions		
	W	H	KG
XBP060	60	160	1,3
XBP080	80	180	1,4
XBP100*	100	200	1,6
XBP120*	120	200	1,7

All sizes in cm.

Package specifications

Outer box					Pallet capacity	
PCS	W	H	D	KG	Euro	Industrial
15	20	101	38	20	330	450
15	20	121	38	22	225	300
10	22	140	38	17	100	120
10	22	140	38	18	100	120

Order quantity: only per 15 / 10* pieces.



Lighting

Banner LED

3 bright power LEDs

Modern and stylish shape



Lighting **Banner LED**

EN

- Powder coating available in black, silver or white
- Connection part suitable on all our Roll-Banners (1)
- 3 m power cable (2)
- Single piece cardboard packaging (3)

DE

- Pulverlackbeschichtung verfügbar in schwarz, silber oder weiß
- Verbindungsteil passend auf jeden unserer Roll-Banners (1)
- 3 m Stromkabel (2)
- Einzelstück Kartonverpackung (3)

NL

- Poedercoating beschikbaar in zwart, zilver of wit
- Verbindingsdeel passend op al onze Roll-Banners (1)
- 3 m stroomkabel (2)
- Kartonnen stuksverpakking (3)

FR

- Recouvert de poudre disponible en noir, argent ou blanc
- Pièce de connexion adaptable sur toutes nos Roll-Banners (1)
- Cable d'alimentation de 3 m (2)
- Emballage par carton individuel (3)

ES

- Lacado disponible en negro, plata o blanco
- Acoplamiento para todos nuestros Roll-Banners (1)
- Cable de alimentación de 3 m (2)
- Envase en cartón individual (3)

Colour temperature 4000 kelvin
Light brightness 600 lumen

Power consumption 8 watt
Equivalent to halogen 80 watt

Length power cable 300 cm
Consistent burning hours 7000 hours

Product specifications

Art. nr.	Colour
BLED3B	●
BLED3S	●
BLED3W	○

All sizes in cm.

Dimensions

W	H	KG
33	10,5	0,4
33	10,5	0,4
33	10,5	0,4

Package specifications

Outer box

PCS	W	H	D	KG
40	28	87	52	18,9
40	28	87	52	18,9
40	28	87	52	18,9

No minimum order quantity.



Lighting

Banner Light Halogen 35 Watt

- 35 watt halogen light
- Including durable transporter bag

6 MONTHS WARRANTY

90



Lighting **Banner light halogeen 35 Watt**

- EN**
- Suitable for any banner type because of clip
 - Bag with zipper (1)
- DE**
- Geeignet für alle Banner-Systeme mittels Universalklemme
 - Tasche mit Reißverschluss (1)
- NL**
- Geschikt voor iedere banner door klem
 - Tas met ritssluiting (1)
- FR**
- Adaptable à toutes les bannières grâce au clip
 - Sac avec fermeture éclair (1)
- ES**
- Adecuado para cualquier tipo de banner con la pinza universal
 - Bolsa con cremallera (1)

Colour temperature 3000 kelvin
Light brightness 400 lumen
Power consumption 35 watt
Length power cable 280 cm
Consistent burning hours 2000 hours



Product specifications

Art. nr.	Colour	Dimensions		
		W	H	KG
BLH35	●	43	13	0,4

All sizes in cm.

Package specifications

Outer box					
PCS	W	H	D	KG	
50	47	94	35,5	26,8	

No minimum order quantity.



Instructional video

WW

Lighting

Banner Light Halogen 50 Watt

- 50 watt halogen light
- Easy mounting

6 MONTHS WARRANTY



Lighting **Banner light halogeen 50 Watt**

- EN**
- Metal casing available in silver or black (1)
 - Single piece carton packing (2)
- DE**
- Metallgehäuse verfügbar in silber oder schwarz (1)
 - In Einzelkartonagen verpackt (2)
- NL**
- Metalen behuizing verkrijgbaar in zilver of zwart (1)
 - Kartonnen stuksverpakking (2)
- FR**
- Boitier métallique disponible en argent ou noire (1)
 - Emballage en carton individuel (2)
- ES**
- Carcasa metálica disponible en plata o negro (1)
 - Envase en cartón individual (2)

Colour temperature 3000 kelvin
Light brightness 500 lumen
Power consumption 50 watt
Length power cable 350 cm
Consistent burning hours 2000 hours



Product specifications

Art. nr.	Colour	Dimensions		
		W	H	KG
BLH50S	●	36	9	0,4
BLH50B	●	36	9	0,4

All sizes in cm.

Package specifications

Outer box					
PCS	W	H	D	KG	
40	53	87	26	18,8	
40	53	87	26	18,8	

No minimum order quantity.



Instructional video

Lighting

Wall LED 50



Colour temperature 4200 kelvin
Light brightness 1100 lumen

Power consumption 11 watt
Equivalent to halogen 110 watt

Length power cable 350 cm
Consistent burning hours 7000 hours

Lighting **Wall LED 50**

- EN**
- Metal casing in white, silver or black
 - Single piece cardboard packaging (1)
 - 1 m power cable + 2,5 m extension cord (2)
 - Including connector suitable on every Pop-Up (3) and connector suitable on several exhibition stands (4)
 - **Optional:** Y-cable connects 2 WLED 50. Maximum capacity is 10 x WLED 50 on 1 power socket (5)

- DE**
- Metallgehäuse verfügbar in weiß, silber oder schwarz
 - Einzelstück Kartonverpackung (1)
 - 1 m Stromkabel + 2,5 m Verlängerungskabel (2)
 - Inklusive Verbindungsteil passend auf jedes Pop-Up (3) und Verbindungsteil passend auf viele Messestände (4)
 - **Optional:** Y-Kabel verbindet 2 WLED 50. Maximale Kapazität ist 10 x WLED 50 auf 1 Strompunkt (5)

- NL**
- Metalen behuizing verkrijgbaar in wit, zilver of zwart
 - Kartonnen stuksverpakking (1)
 - 1 m stroomkabel + 2,5 m verlengkabel (2)
 - Inclusief verbindingsdeel passend op iedere Pop-Up (3) en verbindingsdeel passend op veel beursstands (4)
 - **Optioneel:** Y-kabel verbindt 2 WLED 50. Maximale capaciteit is 10 x WLED 50 op 1 aansluitpunt (5)

- FR**
- Boîtier métallique disponible en blanc, argent ou noir
 - Emballage par carton individuel (1)
 - Câble d'alimentation 1 m + câble d'extension 2,5 m (2)
 - Connexion adaptable sur tous les Pop-Up (3) et connexion adaptable sur de nombreux stands de salon (4) inclus
 - **Optionnel :** Câble-Y permettant de connecter 2 WLED 50. Capacité maximale de 10 x WLED 50 sur 1 prise (5)

- ES**
- Carcasa metálica disponible en blanco, plata o negro
 - Envase en cartón individual (1)
 - Cable de alimentación 1 m + cable de extensión 2,5 m (2)
 - Incluido un acoplamiento indicado para todos los Pop-Up (3) y un acoplamiento indicado para múltiples stands (4)
 - **Opcional:** Cable-Y conecta 2 WLED 50. Capacidad máximo 10 x WLED 50 en 1 solo enchufe (5)

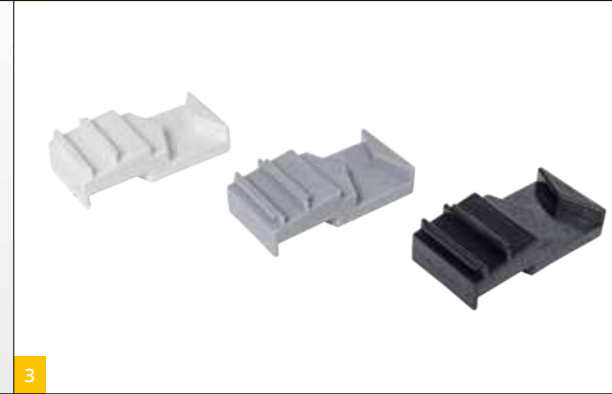

Product specifications

Art. nr.	Colour
WLED50B	●
WLED50S	●
WLED50W	○

All sizes in cm.

Dimensions

W	H	KG
50	13	0,8
50	13	0,8
50	13	0,8

Package specifications

Outer box

PCS	W	H	D	KG
30	93	56,5	33	22,8
30	93	56,5	33	22,8
30	93	56,5	33	22,8

No minimum order quantity.



Instructional video

Lighting

Wall LED 116

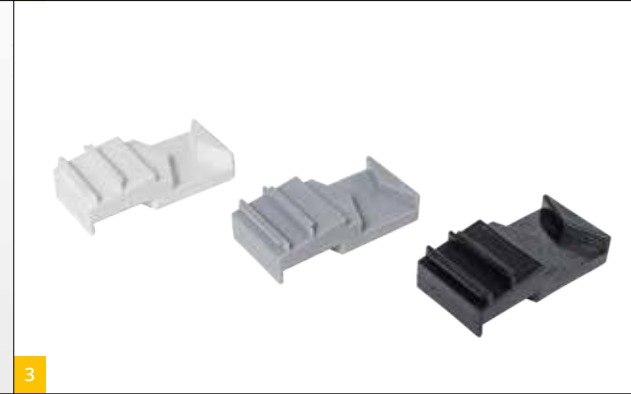
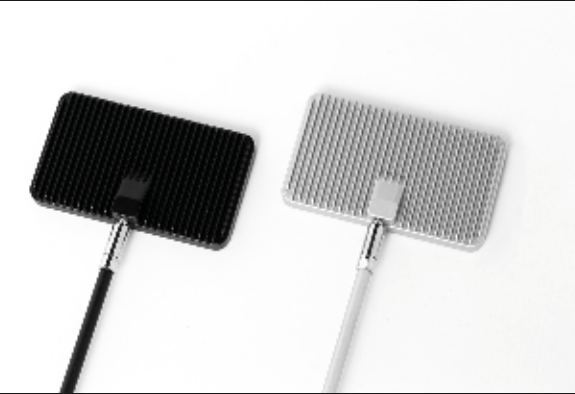

Position power plug: Backside

Colour temperature 4200 kelvin
 Light brightness 2600 lumen
 Power consumption 25 watt
 Equivalent to halogen 250 watt
 Length power cable 350 cm
 Consistent burning hours 7000 hours



Position power plug: Left & right side

Product specifications

Art. nr.	Colour	Position power plug
WLED1160B-BACK	●	Backside
WLED116B-SIDE	●	Left / Right
WLED116S-BACK	●	Backside
WLED116S-SIDE	●	Left / Right

All sizes in cm.

Dimensions

W	H	KG
62,5	15	1,1
62,5	15	1,1
62,5	15	1,1
62,5	15	1,1

Package specifications

Outer box

PCS	W	H	D	KG
25	96	70	37	26,8
25	96	70	37	26,8
25	96	70	37	26,8
25	96	70	37	26,8

No minimum order quantity.

Lighting Wall LED 116

- EN
- Metal casing available in silver or black
 - Single piece cardboard packaging (1)
 - 1 m power cable + 2,5 m extension cord (2)
 - Including connector suitable on every Pop-Up (3) and connector suitable on several exhibition stands (4)
 - **Important:** Double portal of WLED 116 enables interconnection. Maximum capacity is 10 x WLED 116 on 1 power socket

- DE
- Metallgehäuse verfügbar in silber oder schwarz
 - Einzelstück Kartonverpackung (1)
 - 1 m Stromkabel + 2,5 m Verlängerungskabel (2)
 - Inklusive Verbindungssteil passend auf jedes Pop-Up (3) und Verbindungssteil passend auf viele Messestände (4)
 - **Wichtig:** Doppelter Stromanschluss bietet die Option WLED 116 miteinander zu verbinden. Maximale Kapazität sind 10 x WLED 116 pro Strompunkt

- NL
- Metalen behuizing verkrijgbaar in zilver of zwart
 - Kartonnen stuksverpakking (1)
 - 1 m stroomkabel + 2,5 m verlengkabel (2)
 - Inclusief verbindingsdeel passend op iedere Pop-Up (3) en verbindingsdeel passend op veel beursstands (4)
 - **Belangrijk:** Dubbele stekkerpoort biedt optie tot onderlinge verbinding van WLED 116. Maximale capaciteit 10 x WLED 116 op 1 aansluitpunt

- FR
- Boîtier métallique disponible en blanc, argent ou noir
 - Emballage par carton individuel (1)
 - Câble d'alimentation 1 m + câble d'extension 2,5 m (2)
 - Connexion adaptable sur tous les Pop-Up (3) et connexion adaptable sur de nombreux stands de salon (4) inclus
 - **Important :** Double port de connexion sur le WLED 116 qui permet une interconnection. Capacité maximale de 10 x WLED 116 sur 1 prise

- ES
- Carcasa metálica disponible en plata o negro
 - Envase en cartón individual (1)
 - Cable de alimentación 1 m + cable de extensión 2,5 m (2)
 - Incluido un acoplamiento indicado para todos los Pop-Up (3) y un acoplamiento indicado para múltiples stands (4)
 - **Importante:** Doble portal del WLED 116 permite entrelazar. Capacidad máximo 10 x WLED 116 en 1 solo enchufe



Instructional video

Lighting

Wall Light Halogen



Lighting **Wall Light Halogen 150 Watt**

EN

- Metal casing available in silver or black
- Single piece cardboard packaging (1)
- Including connector suitable on every Pop-Up (2) and connector suitable on several exhibition stands (3)

DE

- Metallgehäuse verfügbar in silber oder schwarz
- Einzelstück Kartonverpackung (1)
- Inklusive Verbindungsteil passend auf jedes Pop-Up (2) und Verbindungsteil passend auf viele Messestände (3)

NL

- Metalen behuizing verkrijgbaar in zilver of zwart
- Kartonnen stuksverpakking (1)
- Inclusief verbindingsdeel passend op iedere Pop-Up (2) en verbindingsdeel passend op veel beursstands (3)

FR

- Boîtier métallique disponible en argent ou noir
- Emballage par carton individuel (1)
- Connexion adaptable sur tous les Pop-Up (2) et connexion adaptable sur de nombreux stands de salon (3) inclus

ES

- Carcasa metálica disponible en plata o negro
- Envase en cartón individual (1)
- Incluido un acoplamiento indicado para todos los Pop-Up (2) y un acoplamiento indicado para múltiples stands (3)

Colour temperature 3000 kelvin
Light brightness 1000 lumen

Power consumption 150 watt
Length power cable 350 cm
Consistent burning hours 1000 hours

Product specifications

Art. nr. Colour

WLH150B ●
WLH150S ●

All sizes in cm.

Dimensions

W	H	KG
17	32	0,8
17	32	0,8

Package specifications

Outer box

PCS	W	H	D	KG
30	34	55	95	25
30	34	55	95	25

No minimum order quantity.



Instructional video

6 MONTHS WARRANTY

Lighting Options



Instructional video

Luxurious Light Bag

- EN Suitable for storing 3 lights
- DE Zum aufbewahren von 3 Lampen
- NL Geschikt voor opbergen van 3 lampen
- FR Convient pour contenir 3 lampes
- ES Apropiado para guardar 3 luces



Art. nr.	Product	Suitable light types	W	H	D
L-BAG-M	Luxurious Light Bag M	BLED, BLH35, BLH50, WLED50	16	56	12
L-BAG-L	Luxurious Light Bag L	WLED116, WLH150	16	68	13,5

All sizes in cm.

Banner Light Clip

- EN Suitable for any banner type due to universal clip
- DE Geeignet für alle Banner-Systeme mittels Universalklemme
- NL Geschikt voor iedere banner dankzij universele klem
- FR Adaptable à toutes les bannières grâce au clip universel
- ES Adecuado para todo tipo de banner con la pinza universal



Art. nr.
BLC



Wall Light Clamp Tube

- EN Tube clamp for \varnothing 30 - 34 mm tubes
- DE Rohrklemme für \varnothing 30 - 34 mm Rohre
- NL Buis klem voor buizen van \varnothing 30 - 34 mm
- FR Fixation pour tubes de \varnothing 30 - 34 mm
- ES Abrazadera para tubos de \varnothing 30 - 34 mm

Art. nr. Colour

WLCTB	●
WLCTS	●
WLCWT	○



Wall Light Clamp Wall

- EN Wall clamp up to max 53 mm
- DE Wandklemme bis max. 53 mm
- NL Wandklem tot maximaal 53 mm
- FR Fixation murale max. 53 mm
- ES Abrazadera de pared 53 mm máx.

Art. nr. Colour

WLCWB	●
WLCWS	●
WLCWW	○



Counters

Promotional	104
Professional Original M	106
Professional Original L	106
Professional Square	108
Professional Round	108
Magnetic	110
Fabric	112
Flex Counter	114

Counter Promotional

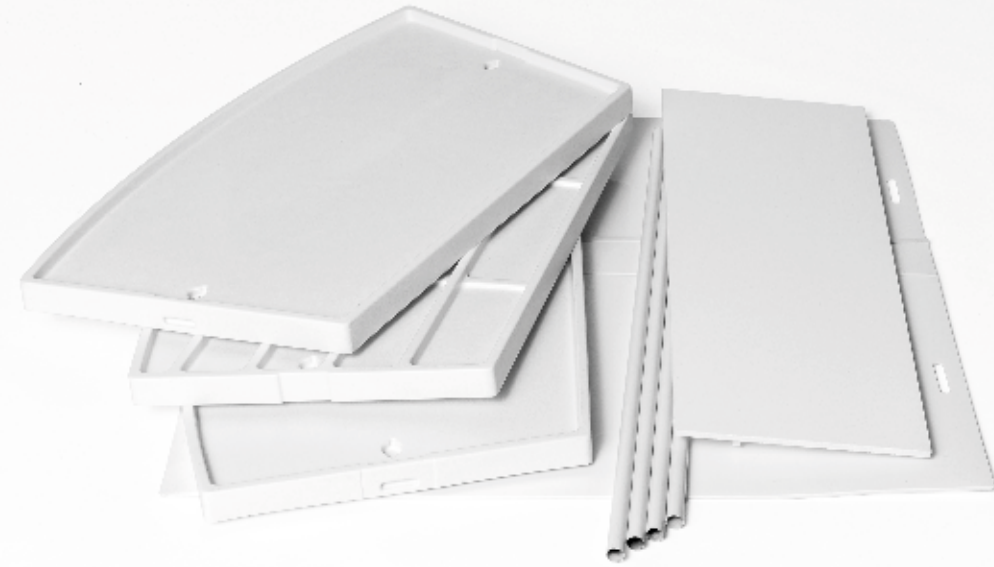

1



2

3



4

- ✔ Display sign at 2 m height
- ✔ Lightweight and stable
- ✔ Can be covered with stickers completely



Counter **Promotional**

EN

- Completely (de)mountable in parts (1)
- Strong support shelf (2)
- Click and mount system (3)
- Braced transporter bag (4)

DE

- Komplett demontierbar (1)
- Starker Einlegeboden mit Stützfunktion (2)
- Klick-Montagesystem (3)
- Verstärkte Transporttasche (4)

NL

- Volledig demonteerbaar in losse onderdelen (1)
- Stevige legplank (2)
- Klik montagesysteem (3)
- Verstevigde transporttas (4)

FR

- Entièrement démontable (1)
- Étagère robuste (2)
- Système 'cliper et monter' (3)
- Sac de transport renforcé (4)

ES

- Completamente desmontable (1)
- Estante de soporte sólido (2)
- Sistema de montaje 'click and go' (3)
- Bolsa de transporte reforzada (4)

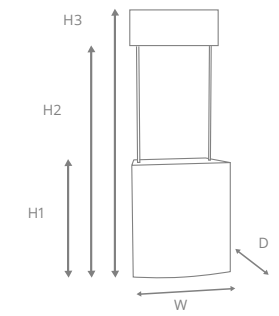

Product specifications

Art. nr.	Dimensions				
	W	H1	H2	H3	D
CROM	82	90	185	215	47

All sizes in cm.

Package specifications

Outer box				
PCS	W	H	D	KG
1	13	94	87	11

No minimum order quantity.

Pallet capacity

Euro	Industrial
12	20



Instructional video

Counter

Professional Original

- Quick and easy to assemble
- Available in 2 sizes
- Lots of space for presentation and storage

104

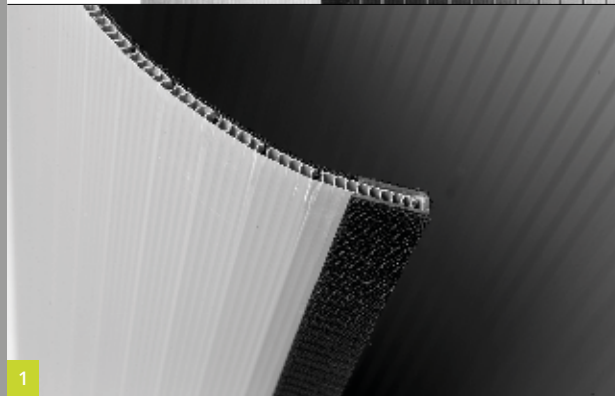
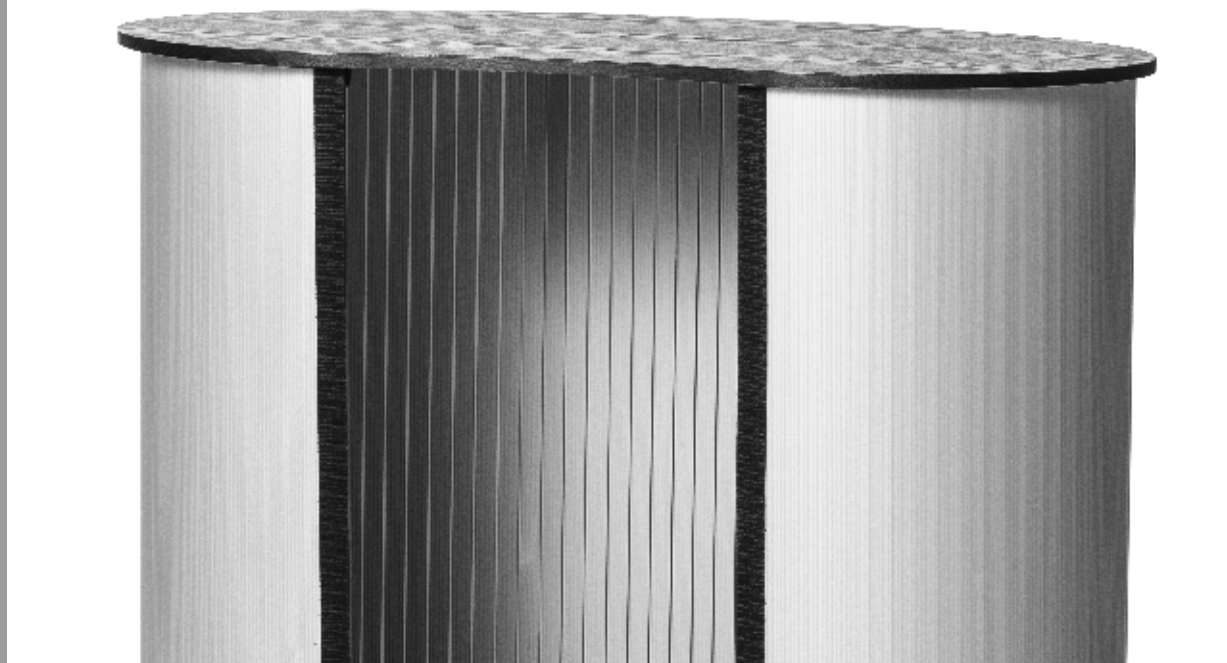

Original M

W = 90



Original L

W = 120

Counter Professional Original M / L

EN

- Extremely stable because of curved shape
- Canal structure sheet with hook velcro (hard); loop velcro (soft) for the print is supplied (1)
- Black tabletop - also available in wood, silver and white for M (2)
- Padded bag for table tops and cylindrical bag with cardboard tube for plastic roll and print (3)
- Optional for M:** plastic shelf (4)
- Optional for L:** wooden shelf (3)

DE

- Extrem stabil mit hoher Standfestigkeit aufgrund gekrümmter Form
- Lamellenbahn, mit Hakenband (hart), Ösen-Hakenband (weich) für Prints, im Lieferumfang enthalten (1)
- Schwarze Thekenplatte, für M auch in Holz, Silber und Weiß erhältlich (2)
- Tasche mit Innenfutter für Holzplatten und Köchertasche mit Papprolle für Kunststoffrolle und Druck (3)
- Optional für M:** Kunststoffeinlegeplatte (4)
- Optional für L:** Einlegeplatte aus Holz (3)

FR

- Stabilité renforcée grâce à sa forme courbée
- Structure alvéolaire avec velcro crochet (côté dur); le velcro boucle (côté souple) pour l'imprimé est également fourni (1)
- Tablette supérieure noire; la version M est disponible également en bois, en argenté et en blanc (2)
- Sac renforcé avec rangement pour tablettes ainsi qu'un sac en cylindre avec tubes en carton pour les imprimés et les rouleaux plastiques (3)
- Optionnel pour M:** Étagère en plastique (4)
- Optionnel pour L:** Étagère en bois (3)

NL

- Extrem stabiel door gebogen vorm
- Lamellenrol voorzien van haak klittenband (hard), lus klittenband (zacht) voor print wordt meegeleverd (1)
- Zwart balieblad, bij M ook beschikbaar in hout, zilver en wit (2)
- Tas met binnenvoering t.b.v. houten bladen en kokertas met kartonnen koker t.b.v. kunststof rol en print (3)
- Optioneel voor M:** kunststof legplank (4)
- Optioneel voor L:** houten legplank (3)

ES

- Extremadamente estable por su forma curvada
- Estructura laminar con gancho de velcro (duro), se suministra un bucle de velcro (suave) para la impresión (1)
- Tablero de mesa negro en M también disponible en madera, plata y blanco (2)
- Bolsa acolchada para los tableros y bolsa cilíndrica con tubo de cartón para el material plástico e impresión (3)
- Opcional para M:** Estante plástico (4)
- Opcional para L:** Estante de madera (3)

Art. nr.	Product
CPOMSHELF	Plastic Shelf (4)
CPOLSHELF	Wooden Shelf (5)

Product specifications

	Art. nr.	Colour	Dimensions		
			W	H	D
Original M	CPOMTTB	●	91	93	48
	CPOMTTW	●	91	93	48
	CPOMTTS	●	91	93	48
	CPOMTTWH	○	91	93	48
Original L	CPOLTTB	●	120	93	48

All sizes in cm.

Package specifications

	PCS	W	H	D	KG	Pallet capacity	
						Euro	Industrial
Table top:	1	50	9	123	12	13	20
Canal str.:	1	22	22	93	3		



Instructional video

Counter

Professional Square & Round

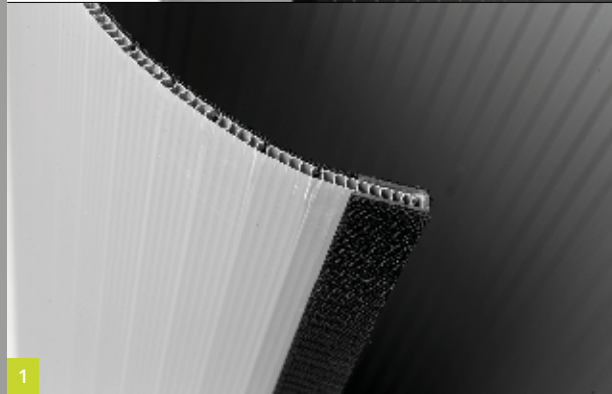

Professional Square

Professional Round



Art. nr. CPSSHELF Product Plastic Shelf (3)

Product specifications

Art. nr.	Colour	Dimensions		
		W	H	D
CPSTTB	●	100	93	40
CPRTTB	●	45	93	

All sizes in cm.

Package specifications

Outer box	PCS	W	H	D	KG
2	48	97	30	16	

No minimum order quantity.

Counter Professional Square & Round

EN

- Extremely stable
- Canal structure sheet with hook velcro (hard); loop velcro (soft) for the print is supplied (1)
- Black table top
- Padded bag for table top and cylindrical bag with cardboard tube for plastic roll and print (2)
- **Optional for Square:** Plastic shelf (3)

DE

- Extrem stabil
- Lamellenbahn, mit Hakenband (hart), Ösen-Hakenband (weich) für Prints, im Lieferumfang enthalten (1)
- Schwarze Thekenplatte
- Tasche mit Innenfutter für Holzplatten und Köchertasche mit Papprolle für Kunststoffrolle und Druck (2)
- **Optional für Square:** Kunststoffeinlegeplatte (3)

NL

- Extreem stabiel
- Lamellenrol voorzien van haak klittenband (hard), lus klittenband (zacht) voor print wordt meegeleverd (1)
- Zwart balieblad
- Tas met binnenvoering t.b.v. houten bladen en kokertas met kartonnen koker t.b.v. kunststof rol en print (2)
- **Optioneel voor Square:** Kunststof legplank (3)

FR

- Stabilité renforcée
- Structure alvéolaire avec velcro crochet (côté dur) ; le velcro boucle (côté souple) pour l'imprimé est également fourni (1)
- Tablette supérieure noire
- Sac renforcé avec rangement pour tablettes ainsi qu'un sac en cylindre avec tubes en carton pour les imprimés et les rouleaux plastiques (2)
- **Optionnel pour Square :** Étagère en plastique (3)

ES

- Extremadamente estable
- Estructura laminar con gancho de velcro (duro), se suministra un bucle de velcro (suave) para la impresión (1)
- Tablero de mesa negro
- Bolsa acolchada para los tableros y bolsa cilíndrica con tubo de cartón para el material plástico e impresión (2)
- **Opcional para Square:** Estante plástico (3)



Instructional video

Counter Magnetic

NEW



Counter **Magnetic**

EN

- Stable and robust aluminium frame (1)
- Table top available in: black / light oak (2)
- Magnetic tape (3-poles) with strong 3M self-adhesive
- 3 bags with inner lining for frame, and tube bag with cardboard tube for print (3)
- Wooden shelf (4)
- **Optional:** extra magnetic tape for new visuals (5)

DE

- Stabiler und robuster Aluminiumrahmen (1)
- Thekenplatte verfügbar in: schwarz / light oak (2)
- Magnetband (3-Polig) mit starke 3M-film
- 3 Taschen mit Innenfutter für Frame und Köchertasche mit Papprolle für Druck (3)
- Einlegeplatte aus Holz (4)
- **Optional:** zusätzliches Magnetband für neue Visuals (5)

NL

- Stabiel en robuust aluminium frame (1)
- Balieblad beschikbaar in: zwart / licht eiken (2)
- Magneetband (3-Polig) met sterke 3M tape
- 3 tassen met binnenvoering t.b.v. het frame en kokertas met kartonnen koker t.b.v. print (3)
- Houten legplank (4)
- **Optioneel:** extra magneetband voor nieuwe visuals (5)

FR

- Cadre stable et robuste en aluminium (1)
- Tablette supérieure disponible en: noir / light oak (2)
- Bande magnétique (3 pôles) avec adhésif 3M
- 3 sacs avec doublure intérieure pour le cadre et sac-tube avec tube en carton pour l'imprimé (3)
- Étagère en bois (4)
- **En option :** bande magnétique supplémentaire pour nouveaux visuels (5)

ES

- Estructura de aluminio estable y robusta (1)
- Tablero disponible en: negro / light oak (2)
- Cinta magnética (3 polos) con autoadhesivo 3M
- 3 bolsas con forro interior para el bastior y bolsa cilíndrica con tubo de cartón para la impresión (3)
- Estante de madera (4)
- **Opcional:** cinta magnética adicional para visuales nuevos (5)

Art. nr.
CMKIT

Product
Extra kit for new visuals

Product specifications

Art. nr.	Colour	Dimensions		
		W	H	D
CMTTB	●	126	97	44
CMTTLO	●	126	97	44

All sizes in cm.

Package specifications

Outer box				
PCS	W	H	D	KG
1	102	42	24	17
1	102	42	24	17

No minimum order quantity.

Pallet capacity

Euro	Industrial
14	20
14	20



Instructional video

Counter Fabric



6: Optional

- ✔ Lightweight pop-up frame
- ✔ Quick and easy to assemble
- ✔ Easily interchangeable print

110



Counter Fabric

EN

- Matt black powder coated aluminium frame (1)
- Wooden shelf in the same colour as table top (2)
- Table top available in: black / wood / silver / white (3)
- Trolley with zipper over full length (4)
- Wide wheel base with ball bearing wheels (5)
- **Optional:** Loop velcro (soft side) available (6)

DE

- Mattschwarzer pulverbeschichteter Aluminiumrahmen (1)
- Einlegeplatte aus Holz in Farbe der Thekenplatte (2)
- Thekenplatte verfügbar in: schwarz / holz / silber / weiß (3)
- Trolley mit Reißverschluss über die ganze Taschenlänge (4)
- Breiter Radstand mit kugelgelagerten Rädern (5)
- **Optional:** Flauschband erhältlich (6)

NL

- Matzwart gepoedercoat aluminium frame (1)
- Houten legplank in dezelfde kleur als balieblad (2)
- Balieblad beschikbaar in: zwart / hout / zilver / wit (3)
- Trolley met ritssluiting over volledige lengte (4)
- Brede wielbasis met kogelgelagerde wielen (5)
- **Optioneel:** Lus klittenband (zachte kant) beschikbaar (6)

FR

- Structure aluminium revêtement poudre noir (1)
- Étagère en bois de la même couleur que la tablette (2)
- Tablette supérieure disponible en: noir / bois / argent / blanc (3)
- Valise avec fermeture éclair sur toute la longueur (4)
- Roues situées de chaque côtés dotées de roulement à billes (5)
- **Optionnel :** Côté souple velcro (femelle) disponible (6)

ES

- Marco de aluminio lacado, color negro mate (1)
- Estante de madera del mismo color que el tablero (2)
- Tablero disponible en: negro / madera / gris plateado / blanco (3)
- Trolley con cremallera en toda la longitud (4)
- Amplia distancia entre ruedas con rodamientos de bolas (5)
- **Opcional:** Velcro de bucle (cara suave) disponible (6)

Optional velcro (6)

Product	Velcro Loop (soft side)
Art. nr.	VEL50L
Width	50mm
Length	25m

Product specifications

Art. nr.	Colour
CFTTB	●
CFTTW	●
CFTTS	●
CFTTWH	○

All sizes in cm.

Dimensions

W	H	D
106	102	40
106	102	40
106	102	40
106	102	40

Package specifications

Outer box

PCS	W	H	D	KG
1	45	115	26	18
1	45	115	26	18
1	45	115	26	18
1	45	115	26	18

No minimum order quantity.

Pallet capacity

Euro	Industrial
13	14
13	14
13	14
13	14



Instructional video

Counter Flex



1



2



3



4



5: Optional



Counter Flex

EN

- Completely foldable aluminium frame (1)
- White table top (2)
- Including 8 translucent PVC panels (3)
- Padded trolley with cover to protect panels and prints (4)
- **Optional:** 8 extra PVC panels for new visuals (5)

Optional PVC Panels for new visuals (5)

Product 8 extra PVC panels
Art. nr. FLP-SET

DE

- Vollständig einklappbarer Aluminiumrahmen (1)
- Weiße Thekenplatte (2)
- Inklusive 8 durchsichtige PVC Paneele (3)
- Gepolsterter Trolley mit Schutz für Paneele und Drucke (4)
- **Optional:** 8 zusätzliche PVC-Paneele für neue Drucke (5)

NL

- Volledig inklapbaar aluminium frame (1)
- Wit balieblad (2)
- Inclusief 8 transparante PVC panelen (3)
- Gevoerde trolley met hoes voor bescherming panelen en prints (4)
- **Optioneel:** 8 extra PVC panelen voor nieuwe prints (5)

FR

- Cadre aluminium entièrement repliable (1)
- Tablette supérieure blanche (2)
- Inclus 8 panneaux transparents (3)
- Sac de transport matelassé avec protections individuelles pour les panneaux et impressions (4)
- **Optionnel :** 8 panneaux en PVC supplémentaires pour les visuels nouveaux (5)

ES

- Estructura de aluminio completamente plegable (1)
- Tablero de mesa blanco (2)
- Incluye 8 paneles translúcidos de PVC (3)
- Trolley acolchado con cubierta para proteger los paneles e impresiones (4)
- **Opcional:** 8 paneles de PVC adicionales para nuevas impresiones (5)

Product specifications

Art. nr.

FLC

All sizes in cm.

Dimensions

Ø	H
58	106

Package specifications

Outer box

PCS	W	H	D	KG
1	63	23	70	17

No minimum order quantity.

Pallet capacity

Euro	Industrial
15	18



Information Systems

Flex Tower	118
Brochure Holder Magnetic	120
Brochure Holder Budget	122
Brochure Holder Easy	124
Brochure Holder ZigZag	126
Brochure Holder Deluxe	128
Poster Rail	130
Poster Frame	132
Poster Stand	134
Panel Base Aluminium	136

Flex Tower



Optional PVC Panels for new visuals (5)

Product 8 extra PVC panels
Art. nr. FLP-SET



Flex Tower

EN

- Completely foldable aluminium frame (1)
- Translucent shelves, max 5 kg
- Including 16 translucent PVC panels (2)
- Built in 15 watt LED spotlight for an eye-catching light effect (3)
- Padded trolley with cover to protect panels and prints (4)
- **Optional:** 8 extra PVC panels for new visuals (5)

DE

- Vollständig einklappbarer Aluminiumrahmen (1)
- Durchsichtige Einlegeplatten, max. 5 kg
- Inklusive 16 durchsichtige PVC Paneele (2)
- 15 Watt LED-Einbauspots für auffällige Lichteffekte (3)
- Gepolsterter Trolley mit Schutz für Paneele und Drucke (4)
- **Optional:** 8 zusätzliche PVC-Paneele für neue Drucke (5)

NL

- Volledig inklapbaar aluminium frame (1)
- Transparante legplaten, max 5 kg
- Inclusief 16 transparante PVC panelen (2)
- Ingebouwde 15 watt LED spot voor een opvallend lichteffect (3)
- Gevoerde trolley met hoes voor bescherming panelen en prints (4)
- **Optioneel:** 8 extra PVC panelen voor nieuwe prints (5)

FR

- Cadre aluminium entièrement repliable (1)
- Étagères transparentes, max 5 kg
- Inclus 16 panneaux transparents (2)
- Spot 15 watts LED intégré pour éclairer les produits (3)
- Sac de transport matelassé avec protections individuelles pour les panneaux et impressions (4)
- **Optionnel :** 8 panneaux en PVC supplémentaires pour les visuels nouveaux (5)

ES

- Estructura de aluminio completamente plegable (1)
- Estantes translúcidos, máx 5 kg
- Incluye 16 paneles translúcidos de PVC (2)
- Incluye proyector LED de 15 vatios llamativo efecto de luz (3)
- Trolley acolchado con funda para la protección de los paneles e impresiones (4)
- **Opcional:** 8 paneles de PVC adicionales para nuevas impresiones (5)

1



2



3



4



5



- ✓ Folding display case with solid aluminium frame
- ✓ Equipped with a built-in 15-watt LED spotlight
- ✓ Easy to use and completely customizable

116

Product specifications

Art. nr.

FLTWR

All sizes in cm.

Dimensions

Ø	H
57	206

Package specifications

Outer box

PCS	W	H	D	KG
1	61	28	68	25.5

No minimum order quantity.

Pallet capacity

Euro	Industrial
12	15



Instructional video

Brochure Holder Magnetic

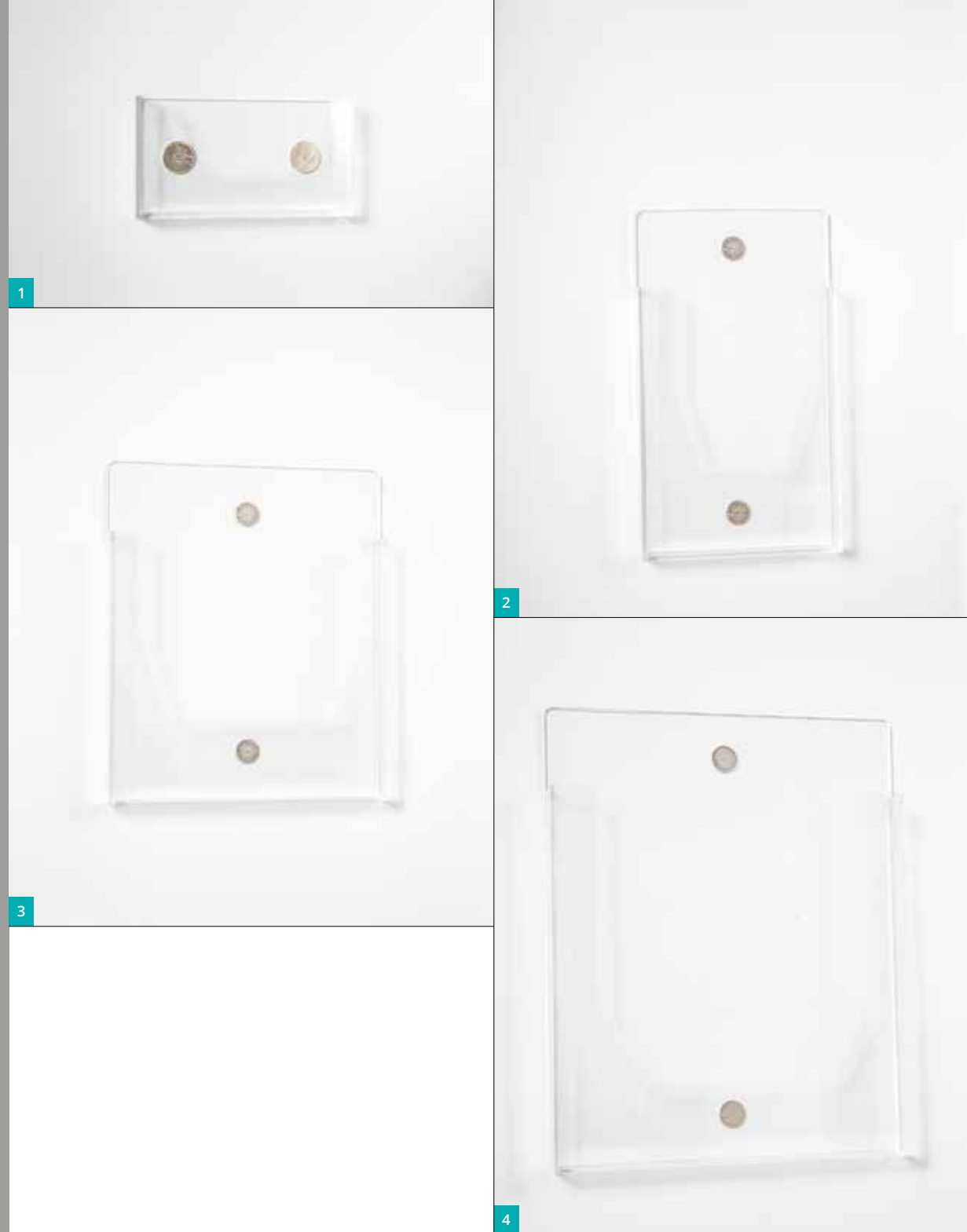

Brochure Holder **Magnetic**

EN

- Size: Business card (1)
- Size: DIN long (2)
- Size: A5 (3)
- Size: A4 (4)
- Attached to banner with two pairs of powerful disk magnets

DE

- Format: Visitenkarte (1)
- Format: DIN lang (2)
- Format: A5 (3)
- Format: A4 (4)
- Mit zwei kraftvollen Scheibenmagneten am Banner befestigt

NL

- Formaat: Visitekaartje (1)
- Formaat: DIN lang (2)
- Formaat: A5 (3)
- Formaat: A4 (4)
- Bevestigd aan de banner met twee paar krachtige schijfmagneten

FR

- Format: Carte de visite (1)
- Format: DIN long (2)
- Format: A5 (3)
- Format: A4 (4)
- Suspendu au banner par deux paires de aimants puissants

ES

- Tamaño: Tarjeta de visita (1)
- Tamaño: DIN largo (2)
- Tamaño: A5 (3)
- Tamaño: A4 (4)
- Unido al banner con dos pares de imanes potentes en forma de disco

Product specifications

Art. nr.	Size	Dimensions			
		W	H	D	Magnets
BHMB*	Business card	9.5	5	1.1	Ø 15x2 mm
BHMDIN	Din long	11.5	20.5	1.1	Ø 15x2 mm
BHMA5	A5	16.5	20.5	1.5	Ø 15x2 mm
BHMA4	A4	23	29.5	1.8	Ø 18x3 mm

All sizes in cm.

Package specifications

Outer box

PCS	W	H	D	KG
20	14	59	22	6
10	16	116	24	10
10	21	116	24	11
10	28	151	31	25

Order quantity: only per 10 / 20* pieces.



Brochure Holder Budget

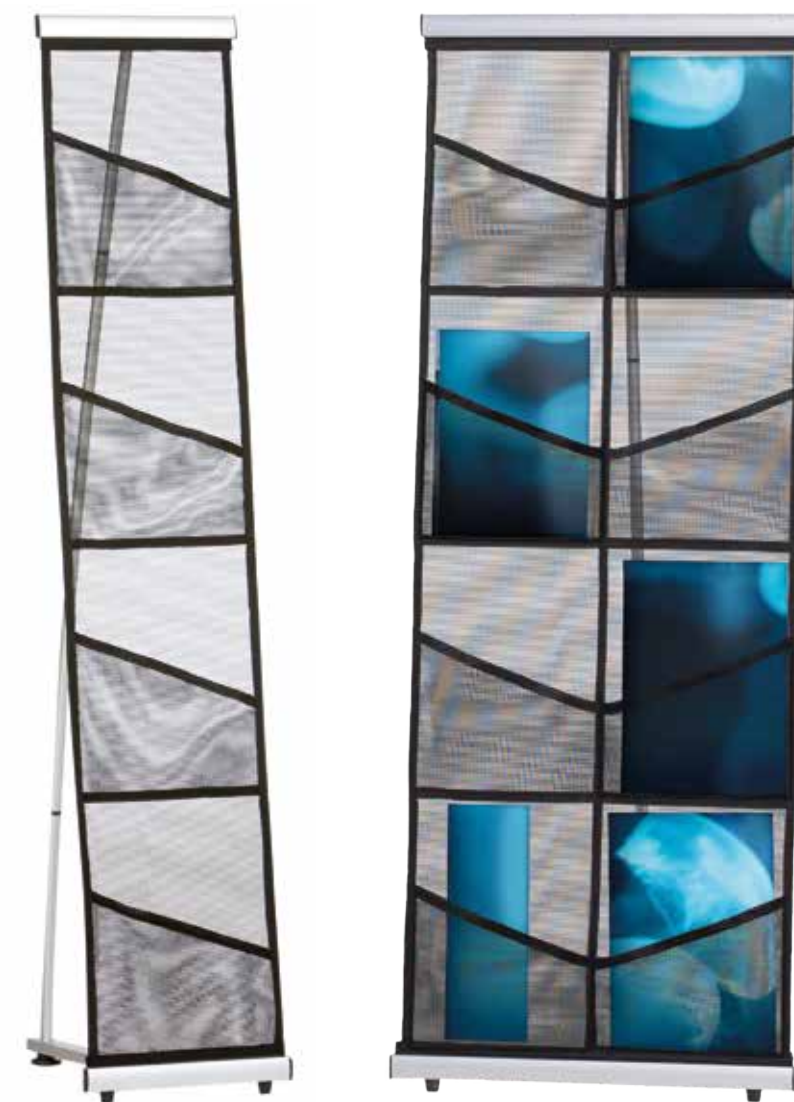

Brochure Holder **Budget**

EN

- Screwed twist-foot (1)
- Padded bag with zipper (2)

DE

- Verschraubter Schwenkfuß (1)
- Tasche mit Innenfutter und Reißverschluss (2)

NL

- Geschroefde draaivoet (1)
- Tas met binnenvoering en ritssluiting (2)

FR

- Pieds à fermeture vissé (1)
- Sac renforcé avec fermeture éclair (2)

ES

- Pie giratorio atornillado (1)
- Bolsa acolchada con cremallera (2)

Product specifications

Art. nr.	Dimensions			
	Size	W	H	D
BHB4	A4 (Single)	27	135	41
BHB8	A4 (Double)	51	135	41

All sizes in cm.

Package specifications

Outer box				
PCS	W	H	D	KG
10	45	19	60	12
10	45	19	60	15

Order quantity: only per 10 pieces.

Pallet capacity

Euro	Industrial
350	400
350	400



Instructional video

Brochure Holder Easy



1



2

Brochure Holder **Easy**

EN

- Padded bag with zipper (1)
- Single piece cardboard packaging (2)

DE

- Tasche mit Innenfutter und Reißverschluss (1)
- In Einzelkartonagen verpackt (2)

NL

- Tas met binnenvoering en ritssluiting (1)
- Kartonnen stuksverpakking (2)

FR

- Sac renforcé avec fermeture éclair (1)
- Emballage en carton individuel (2)

ES

- Bolsa acolchada con cremallera (1)
- Embalaja en cartón individual (2)



Product specifications

Art. nr.	Dimensions		
	W	H	D
BHE5	24	144	30

All sizes in cm.

Package specifications

Outer box	PCS	W	H	D	KG

No minimum order quantity.

Pallet capacity

Euro	Industrial
40	60



Brochure Holder ZigZag



1



2



3



Brochure Holder **ZigZag**

EN

- Easy build up
- Aluminium frame with screwed connections (1)
- Equipped with 4 rubber feet (2)
- Solid case with foam with protection inside (3)

DE

- Einfach aufzubauen
- Aluminiumrahmen mit Schraubverbindungen (1)
- Ausgestattet mit 4 Gummifüßen (2)
- Solider Transportkoffer mit Schaumstoffpolsterung auf der Innenseite (3)

NL

- Eenvoudige opbouw
- Aluminium frame met geschroefde verbindingen (1)
- Voorzien van 4 rubberen voetjes (2)
- Transportkoffer met schuimbeschermer aan binnenkant (3)

FR

- Montage facilité
- Cadre en aluminium équipé de joints vissés (1)
- Équipé de 4 pieds en caoutchouc (2)
- Valise de transport robuste avec intérieur en mousse (3)

ES

- Fácil de montar
- Estructura de aluminio con conexiones roscadas (1)
- Equipado con 4 pies de goma (2)
- Maleta resistente con protección interior de gomaespuma (3)

Format A4
Tray depth 2,5cm

Product specifications

Art. nr.	Type
BHZZW	Wood
BHZZA	Acrylic
BHZZM	Matt

All sizes in cm.

Dimensions

W	H	D
28	143	35
28	143	35
28	143	35

Package specifications

Outer box				
PCS	W	H	D	KG
3	49	55	37	27
3	49	55	37	27
3	49	55	37	27

No minimum order quantity.

Pallet capacity

Euro	Industrial
48	52
48	52
48	52



Instructional video

Brochure Holder Deluxe

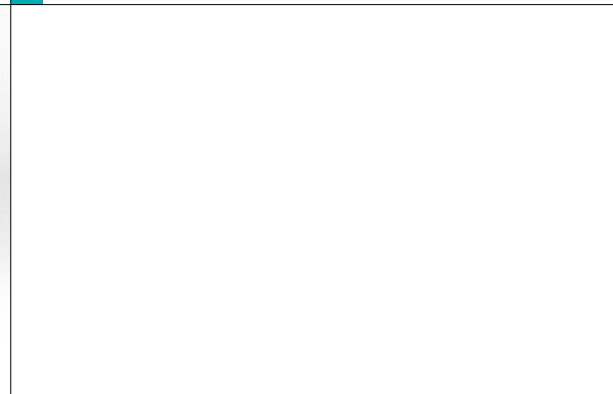
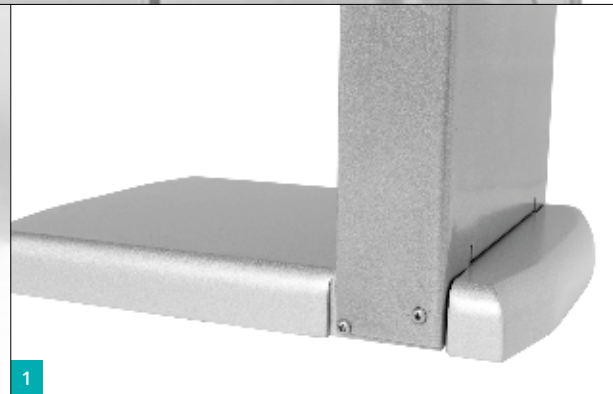
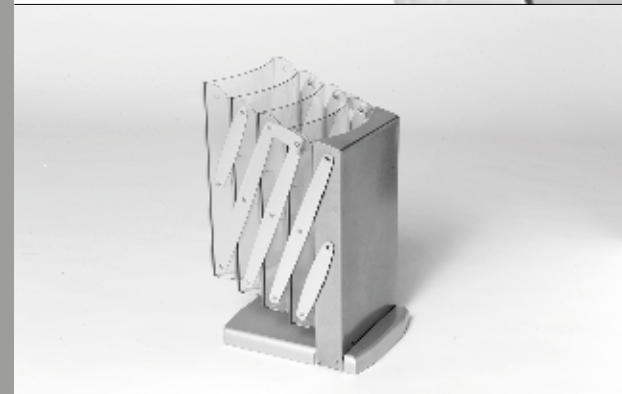

Brochure Holder **Deluxe**

EN

- Extremely stable brochure holder
- Easy build up
- Heavy duty base (1)
- Reinforced padded bag with zipper (2)

DE

- Sehr stabiler Prospekthalter
- Einfach aufzubauen
- Schwerlastfuß (1)
- Verstärkte gefütterte Tasche mit Reißverschluss (2)

NL

- Zeer stabiele brochurehouder
- Eenvoudige opbouw
- Stevige basis (1)
- Verstevigde gevoerde tas met ritssluiting (2)

FR

- Porte brochure extrêmement stable
- Montage facilité
- Base lourde (1)
- Sac renforcé et rembourré avec fermeture éclair (2)

ES

- Portafolletos extremadamente estable
- Fácil de montar
- Base sólida (1)
- Bolsa acolchada reforzada con cremallera (2)

Format A4
Tray depth 5 cm

Product specifications

Art. nr.	Dimensions		
	W	H	D
BHL	24	156	29

All sizes in cm.

Package specifications

Outer box	PCS	W	H	D	KG

No minimum order quantity.

Pallet capacity

Euro	Industrial
24	36



Instructional video

Poster Rail



1

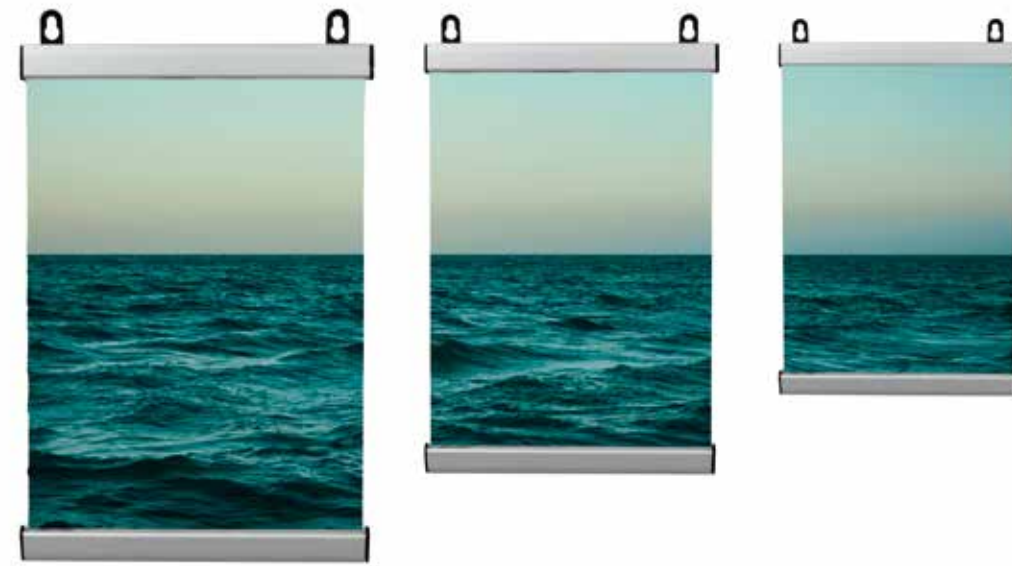

Poster Rail

EN

- Aluminium poster rail in 7 different width sizes
- Snap rail on top and bottom
- Easily interchangeable prints
- Wall or ceiling mounted
- Single piece packaging
- Including 2 hooks, screws and plugs (1)

DE

- Aluminium-Klapprahmen in 7 verschiedenen Größen
- Klemmschiene oben und unten
- Drucke einfach auswechselbar
- Befestigung an Wand oder Decke
- Einzelstück Verpackung
- Einschließlich 2 Haken, Schrauben und Dübeln (1)

NL

- Aluminium posterrail in 7 verschillende breedte maten
- Klemprofiel boven en onder
- Makkelijk verwisselbare prints
- Bevestig aan de muur of het plafond
- Stuksverpakking
- Inclusief 2 ophangogen, schroeven en pluggen (1)

FR

- Cadre à clipser en aluminium dans 7 largeurs différentes
- Rail à clips en haut et en bas
- Visuels facilement interchangeables
- Fixé au mur ou au plafond
- Emballage individuel
- 2 œillets de suspension, vis et chevilles inclus (1)

ES

- Perfil de aluminio en 7 anchos diferentes
- Perfil superior e inferior abatible
- Visuales fácilmente intercambiables
- Montaje en muro o techo
- Empaquetado por unidad
- Incluye 2 ganchos, tornillos y tapones (1)

Product specifications

Art. nr.

PR-A4
PR-A3
PR-A2
PR-A1*
PR-A0*
PR-100*
PR-120*

All sizes in cm.

Dimensions

W

21
29,7
42
59,4
84,1
100
120

Package specifications

Outer box

PCS	W	H	D	KG
40	24	30	17	4,3
40	33	30	17	5,8
40	46	30	17	7,9
40	64	30	17	10,9
40	87	30	17	15,5
40	102	30	17	21,4
40	122	30	17	25

Order quantity: only per 10 / 5* pieces.



Poster Frame



1



2: Landscape and portrait

3



Poster **Frame**

EN

- Aluminium snap frame in 4 different sizes (1)
- Width frame: 25 mm
- Adjustable to landscape & portrait (2)
- Single piece cardboard packaging
- Including screws and plugs (3)

DE

- Aluminium-Klapprahmen in 4 verschiedenen Größen (1)
- Breite des Rahmens: 25 mm
- Montierbar in Landschaft- und Portraitformat (2)
- Einzelstück Kartonverpackung
- Einschließlich Schrauben und Dübeln (3)

NL

- Aluminium kliklijst in 4 verschillende maten (1)
- Breedte lijst: 25 mm
- Landschape en portrait monteerbaar (2)
- Kartonnen stuksverpakking
- Inclusief schroeven en pluggen (3)

FR

- Cadre à clipser en aluminium dans 4 tailles différentes (1)
- Largeur de cadre : 25 mm
- Ajustable en mode paysage ou portrait (2)
- Emballage par carton individuel
- Vis et chevilles incluses (3)

ES

- Marco de aluminio en 4 tamaños distintos (1)
- Ancho del marco: 25 mm
- Ajustable en posición de paisaje o de retrato (2)
- Embalaje en cartón individual
- Incluye tornillos y tapones (3)

Product specifications

Art. nr.

PF-A4
PF-A3
PF-A2
PF-A1*

Dimensions

W	H
21	29,7
29,7	42
42	59,4
59,4	84,1

All sizes in cm.

Package specifications

Outer box

PCS	W	H	D	KG
10	26	2	34,5	0,6
10	34,5	2	46,5	0,7
10	46,5	2	64,5	1,2
5	64,5	2	89,5	2,1

Order quantity: only per 10 / 5* pieces.



Poster Stand



Poster **Stand**

EN

- Aluminium snap frame A4 or A3 (1)
- Brochure holder acrylic (2)
- Adjustable to landscape & portrait (3)
- Rubber protection under base (4)
- Easily (de)mountable in parts (5)
- Padded transporter bag (6)

DE

- Aluminium-Klapprahmen A4 oder A3 (1)
- Prospekthalter Acryl (2)
- Montierbar in Landschaft- und Portraitformat (3)
- Gummischutz am Fuß (4)
- Einfach zu demontieren (5)
- Gefütterte Transporttasche (6)

NL

- Aluminium kliklijst A4 of A3 (1)
- Brochurehouder acryl (2)
- Landscape en portrait monteerbaar (3)
- Rubberen bescherming onder voet (4)
- Eenvoudig demonteerbaar (5)
- Gevoerde transporttas (6)

FR

- Cadre à clipser A4 ou A3 en aluminium (1)
- Porte-brochure acrylique (2)
- Ajustable en mode paysage ou portrait (3)
- Protection en caoutchouc sous la base (4)
- Facilement démontable (5)
- Sac de transport rembourré (6)

ES

- Marco de aluminio A4 o A3 (1)
- Portafolletos acrílico (2)
- Ajustable en posición de paisaje o de retrato (3)
- Base protegida con lámina de goma (4)
- Fácilmente desmontable (5)
- Bolsa de transporte acolchada (6)

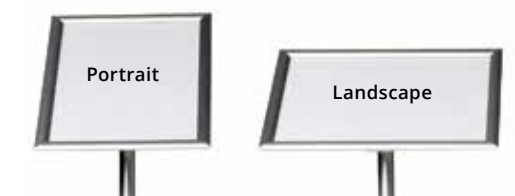

PSA4 & PSA3: Adjustable to landscape & portrait

Product specifications

Art. nr.	Dimensions	
	Base	H
PSA4	Ø 33	114
PSA3	Ø 33	118
PSA4A	Ø 33	118

All sizes in cm.

Package specifications

Outer box					
PCS	W	H	D	KG	
4	8	39	36	5	
4	8	39	47	5	
4	8	39	36	5	

No minimum order quantity.

Pallet capacity

Euro	Industrial
120	150
96	120
120	150



Instructional video

Panel Base Aluminium

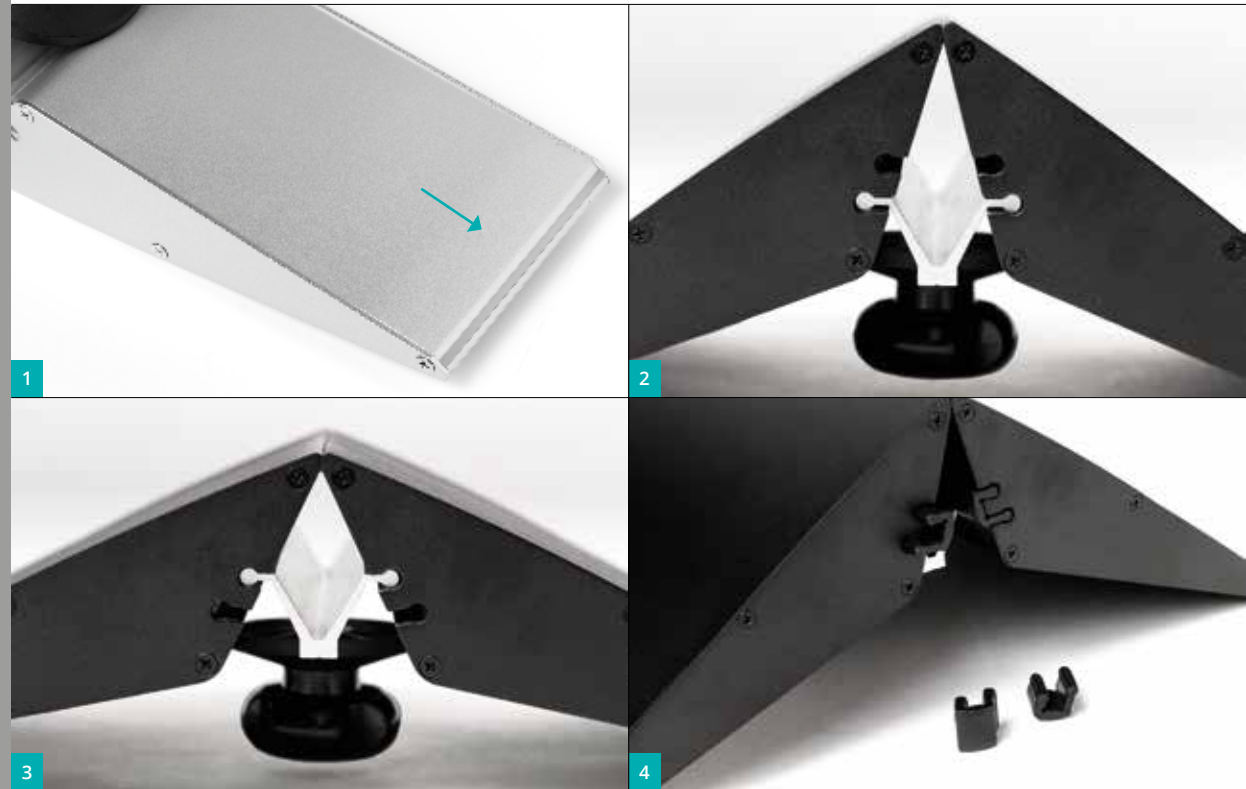

Panel Base **Aluminium**

EN

- Stable aluminium base
- Anti-slip silicon (1)
- Stand 1: panel thickness 3 - 18 mm (2)
- Stand 2: panel thickness 18 - 26 mm (3)
- Stoppers (4)

DE

- Stabiler Aluminiumfuß
- Antirutsch-Silikon (1)
- Position 1: Wandstärke 3 - 18 mm (2)
- Position 2: Wandstärke 18 - 26 mm (3)
- Sicherheitsklammern (4)

NL

- Stabiele aluminium voet
- Antislip silicone (1)
- Stand 1: paneeldikte 3 - 18 mm (2)
- Stand 2: paneeldikte 18 - 26 mm (3)
- Stopdopjes (4)

FR

- Base en aluminium stable
- Silicone antidérapant (1)
- Stand 1 : épaisseur du panneau 3 - 18 mm (2)
- Stand 2 : épaisseur du panneau 18 - 26 mm (3)
- Calles (4)

ES

- Base de aluminio estable
- Silicona antideslizante (1)
- Posición 1: grosor del panel 3 - 18 mm (2)
- Posición 2: grosor del panel 18 - 26 mm (3)
- Tapones (4)

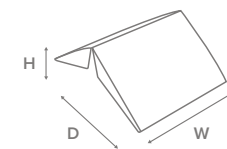

Product specifications

Art. nr.	Colour
PBAS10	●
PBAS30*	●
PBAS50*	●
PBAB10	●
PBAB30*	●
PBAB50*	●

PBAS10
PBAS30*
PBAS50*

PBAB10
PBAB30*
PBAB50*

All sizes in cm.

Dimensions

W	H	D
10	14	38
30	14	38
50	14	38

Package specifications

Outer box

PCS	W	H	D	KG
4	32	25	41	6
2	32	33	41	7
2	32	53	41	10

Order quantity: only per 4 / *2 pieces.

Pallet capacity

Euro	Industrial
192	188
72	96
44	60



Outdoor

Streetboard	140
Outdoor Banner	142

Outdoor Streetboard



- ✓ Suitable for double-sided use
- ✓ Easy to move
- ✓ User friendly and vandal-proof



Outdoor **Streetboard**

EN

- Aluminium snap frame with transparent PVC protective covers
- Plastic water tank: 32 liter water, 59 kg sand (1)
- Stable transport wheels (2)

DE

- Aluminium-Klapprahmen mit transparenten PVC-Einlagen
- Kunststoff-Wassertank, 32 Liter Wasser, 59 kg Sand (1)
- Stabile Transporträder (2)

NL

- Aluminium kliklijst met transparante PVC voorzetvellen
- Kunststof watertank, 32 liter water, 59 kg zand (1)
- Stabiele transportwielen (2)

FR

- Cadre à clipser en aluminium avec feuilles de protection transparentes en PVC
- Réservoir à eau en plastique, 32 litres d'eau, 59 kg sable (1)
- Roulettes de transport stabilisées (2)

ES

- Marco de aluminio tipo clic con láminas frontales de PVC transparente
- Depósito de plástico para 32 litros de agua, 59 kg de arena (1)
- Ruedas de transporte estables (2)

Water resistant (Splash proof)

Product specifications

Art. nr.	Size	Dimensions		
		W	H	D
SBA1	A1 (594 x 841 mm)	80	115	51

All sizes in cm.

Package specifications

Outer box	PCS	W	H	D	KG	Pallet capacity	
						Euro	Industrial
	1	67	103	22	16	10	12

No minimum order quantity.



Instructional video

Outdoor Banner



1



2



3



4



Outdoor Banner

EN

- Water tank 18 liter (1)
- Adjustable in height with aluminium clip (2)
- Fiberglass banner holders (3)
- Delivered in 2 braced transporter bags (4)

DE

- Wassertank 18 Liter (1)
- In Höhe verstellbar, mit Aluminium Clip (2)
- Fiberglas-Grafikhalter (3)
- Lieferung in 2 verstärkten Transporttaschen (4)

NL

- Watertank 18 liter (1)
- In hoogte verstelbaar met aluminium clip (2)
- Fiberglas bannerhouders (3)
- Geleverd in 2 verstevigde transporttassen (4)

FR

- Réservoir à eau de 18 litres (1)
- Hauteur ajustable avec clip en aluminium (2)
- Porte-bannière en fibre de verre (3)
- Livré dans 2 sacs de transport renforcés (4)

ES

- Depósito para 18 litros de agua (1)
- Altura ajustable con clip de aluminio (2)
- Portabandera de fibra de vidrio (3)
- Entrega en 2 bolsas de transporte reforzadas (4)



- ✓ Adjustable in height
- ✓ Stable and heavy-weight base
- ✓ Easy attachment of print

Product specifications

Art. nr.

OB180

All sizes in cm.

Dimensions

W	H	KG
80	180	4

Package specifications

Package

PCS	W	H	D	KG
2	40	102	24	8

No minimum order quantity.

Pallet capacity

Euro	Industrial
40	48



Beach Flag Alu Wind



1



2



3



4



5: Optional



Beach Flag **Alu Wind**

EN

- 1-part fiberglass top (1)
- Black powder coated tubes (2)
- Tube diameter 28 mm, tube thickness 1,5 mm
- Clamp ring for attachment flag (3)
- Including beach flag bag with carrying cord (4)
- **Optional:** Luxurious padded transporter bag for multiple beach flag products (5)

DE

- Fiberglasspitze aus einem Teil gefertigt (1)
- Schwarze pulverbeschichtete Rohre (2)
- Rohrdurchmesser 28 mm, Wandstärke 1,5 mm
- Klemmring zur Befestigung der Fahne (3)
- Inklusive Beachflagtasche mit Tragegurt (4)
- **Optional:** Verstärkte Transporttasche für mehrere Beachflagprodukte (5)

NL

- Eendelige fiberglas bovenspriet (1)
- Zwart gepoedercoate buizen (2)
- Buisdiameter 28 mm, wanddikte 1,5 mm
- Klemring voor bevestiging vlag (3)
- Inclusief beachflagtas met draagkoord (4)
- **Optioneel:** Luxe gevoerde transporttas voor meerdere beachflag producten (5)

FR

- Tige supérieure du mât en fibre de verre (1)
- Tubes avec revêtement peinture poudrée noire (2)
- Tube de 28 mm de diamètre, épaisseur de tube 1,5 mm
- Anneau resserable permettant l'ajustement de la tension de l'impression (3)
- Sac pour le beachflag avec lanières de transport incluses (4)
- **Optionnel :** Sac de transport design et renforcé pouvant être utilisé pour différents beachflags (5)

ES

- Pieza final de fibra de vidrio en la parte superior del mástil (1)
- Tubos lacado en negro mate (2)
- Diámetro del tubo 28 mm, grueso del tubo 1,5 mm
- Anillo de sujeción para la fijación de la bandera (3)
- Bolsa de transporte para beachflag con asa de cordón (4)
- **Opcional:** Bolsa de transporte acolchada de lujo para múltiples productos beachflag (5)

Product specifications

Art. nr.

BFAW205
BFAW255
BFAW310
BFAW360
BFAW415
BFAW465
BFAW520

All sizes in cm.

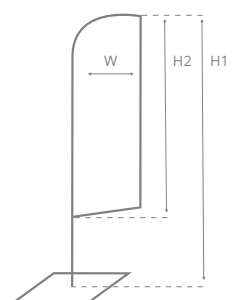

Flag size

W	H2
89	165
89	200
89	240
89	290
89	345
89	395
89	450

Pole height

H1
205
255
310
360
415
465
520

Package specifications

Outer box

PCS	W	H	D
30	143	33	22
25	143	33	22
20	143	33	22
18	143	33	22
16	143	33	22
15	143	33	22
12	143	33	22

No minimum order quantity.

Pallet capacity

Euro	Industrial
330	450
275	375
220	300
198	270
176	240
165	225
132	180



Instructional video

Beach Flag Alu Drop



Beach Flag **Alu Drop**

- EN**
- Two-piece fiberglass top (1)
 - Black powder coated tubes (2)
 - Tube diameter 28 mm, tube thickness 1,5 mm
 - Clamp ring for attachment flag (3)
 - Including beach flag bag with carrying cord (4)
 - **Optional:** Luxurious padded transporter bag for multiple beach flag products (5)

- DE**
- Zweiteilige Fiberglasspitze (1)
 - Schwarze pulverbeschichtete Rohre (2)
 - Rohrdurchmesser 28 mm, Wandstärke 1,5 mm
 - Klemmring zur Befestigung der Fahne (3)
 - Inklusive Beachflagtasche mit Tragegurt (4)
 - **Optional:** Verstärkte Transporttasche für mehrere Beachflagprodukte (5)

- NL**
- Tweedelige fiberglas bovenspriet (1)
 - Zwart gepoedercoate buizen (2)
 - Buisdiameter 28 mm, wanddikte 1,5 mm
 - Klemring voor bevestiging vlag (3)
 - Inclusief beachflagtas met draagkoord (4)
 - **Optioneel:** Luxe gevoerde transporttas voor meerdere beachflag producten (5)

- FR**
- Tige supérieure en fibre de verre formée de deux parties (1)
 - Tubes avec revêtement peinture poudrée noire (2)
 - Tube de 28 mm de diamètre, épaisseur de tube 1,5 mm
 - Anneau resserable permettant l'ajustement de la tension de l'impression (3)
 - Sac pour le beachflag avec lanières de transport incluses (4)
 - **Optionnel :** Sac de transport design et renforcé pouvant être utilisé pour différents beachflags (5)

- ES**
- Parte superior de fibra de vidrio en dos piezas (1)
 - Rubos lacados en negro mate (2)
 - Diámetro de tubo 28 mm, grosor de tubo 1,5 mm
 - Anillo de sujeción para la fijación de la bandera (3)
 - Bolsa de transporte para beachflag con asa de cordón (4)
 - **Opcional:** Bolsa de transporte acolchada de lujo para múltiples productos beachflag (5)

- ✓ Thick aluminium flag pole
- ✓ Always tight thanks to drop shape

Product specifications

Art. nr.	Flag size		Pole height
	W	H2	
BFAD235	87	190	235
BFAD290	87	245	290
BFAD345	87	290	345
BFAD400	107	335	400
BFAD520	127	435	520

All sizes in cm.

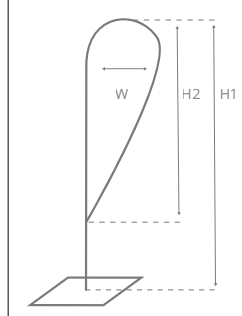

Package specifications

Outer box				Pallet capacity	
PCS	W	H	D	Euro	Industrial
25	143	33	22	275	375
20	143	33	22	220	300
18	143	33	22	198	270
16	143	33	22	176	240
12	143	33	22	132	180

No minimum order quantity.



Instructional video

Beach Flag Alu Square



1



2



3



4: Optional

- ✓ Thick aluminium flag pole
- ✓ Easy-to-design shape



Beach Flag **Alu Square**

EN

- Heavy duty angle connection (1)
- Black powder coated tubes
- Tube diameter 28 mm, tube thickness 1,5 mm
- Clamp ring for attachment flag (2)
- Including beach flag bag with carrying cord (3)
- **Optional:** Luxurious padded transporter bag for multiple beach flag products (4)

DE

- Robuster Winkelanschluss (1)
- Schwarze pulverbeschichtete Rohre
- Rohrdurchmesser 28 mm, Wandstärke 1,5 mm
- Klemmring zur Befestigung der Fahne (2)
- Inklusive Beachflagtasche mit Tragegurt (3)
- **Optional:** Verstärkte Transporttasche für mehrere Beachflagprodukte (4)

NL

- Stevige hoekverbinding (1)
- Zwart gepoedercoate buizen
- Buisdiameter 28 mm, wanddikte 1,5 mm
- Klemring voor bevestiging vlag (2)
- Inclusief beachflagtas met draagkoord (3)
- **Optioneel:** Luxe gevoerde transporttas voor meerdere beachflag producten (4)

FR

- Connection angulaire renforcé (1)
- Tubes avec revêtement peinture poudrée noire (2)
- Tube de 28 mm de diamètre, épaisseur de tube 1,5 mm
- Anneau resserable permettant l'ajustement de la tension de l'impression (3)
- Sac pour le beachflag avec lanières de transport incluses (4)
- **Optionnel :** Sac de transport design et renforcé pouvant être utilisé pour différents beachflags (5)

ES

- Unión angular sólida (1)
- Tubos lacado en negro mate
- Diámetro de tubo 28 mm, espesor de pared 1,5 mm
- Anillo de sujeción para la fijación de la bandera (3)
- Bolsa de transporte para beachflag con asa de cordón (4)
- **Opcional:** Bolsa de transporte acolchada de lujo para múltiples productos beachflag (5)

Product specifications

Art. nr.	Flag size		Pole height
	W	H2	
BFAS240	60	155	240
BFAS350	85	265	350
BFAS460	85	375	460

All sizes in cm.

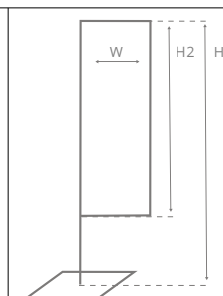

Package specifications

Outer box				Pallet capacity	
PCS	W	H	D	Euro	Industrial
16	143	33	22	176	240
13	143	33	22	143	195
11	143	33	22	121	165

No minimum order quantity.



Instructional video

Beach Flag Fiber Wind & Drop



4: Optional

- ✓ Flexible fiberglass flagpole
- ✓ One system for two shapes

150



Instructional video

Beach Flag **Fiber Wind & Drop**

EN

- Fiberglass top (1)
- Fiberglass tubes diameter 28 mm, wall thickness 1,5 mm aluminium reinforcement diameter 31 mm
- Clamp ring for attachment flag (2)
- Including beach flag bag with carrying cord (3)
- **Optional:** Luxurious padded transporter bag for multiple beach flag products (4)

DE

- Glasfiberspitze (1)
- Fiberglas-Rohrdurchmesser 28 mm, Wandstärke 1,5 mm, Aluminiumverstärkung Durchmesser 31 mm
- Klemmring zur Befestigung der Fahne (2)
- Inklusive Beachflagtasche mit Tragegurt (3)
- **Optional:** Verstärkte Transporttasche für mehrere Beachflagprodukte (4)

NL

- Fiberglas bovenspriet (1)
- Fiberglas buisdiameter 28 mm, wanddikte 1,5 mm, aluminium versterking diameter 31 mm
- Klemring voor bevestiging vlag (2)
- Inclusief beachflagtas met draagkoord (3)
- **Optioneel:** Luxe gevoerde transporttas voor meerdere beachflag producten (4)

FR

- Tige supérieure en fibre de verre (1)
- Tubes de fibre de 28 mm de diamètre, épaisseur du tube 1,5 mm, avec renforcement aluminium 31 mm de diamètre
- Anneau resserable permettant l'ajustement de la tension de l'impression (2)
- Sac pour le beachflag avec lanières de transport incluses (3)
- **Optionnel :** Sac de transport design et renforcé pouvant être utilisé pour différents beachflags (4)

ES

- Pieza superior del mástil de fibra de vidrio (1)
- Tubos de fibra de vidrio de 28 mm de diámetro, grosor del tubo 1,5 mm, con refuerzo de aluminio 31 mm de diámetro
- Anillo de sujeción para la fijación de la bandera (2)
- bolsa de transporte para beachflag con asa de cordón (3)
- **Opcional:** Bolsa de transporte acolchada de lujo para múltiples productos beachflag (4)

Product specifications

Art. nr.

- BFF-S**
- BFF-M**
- BFF-L**
- BFF-XL**

All sizes in cm.

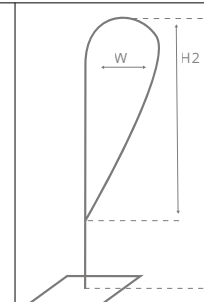

DROP SHAPE

W	H2	H1
58	143	185
69	181	240
112	238	310
138	370	420

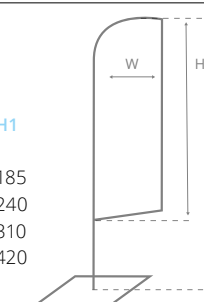

WIND SHAPE

W	H2	H1
47	156	210
65	194	267
78	285	360
78	403	488

Product specifications

Outer box

PCS	W	H	D
40	143	33	22
35	143	33	22
28	143	33	22
25	143	33	22

No minimum order quantity.

Pallet capacity

Euro	Industrial
440	600
385	525
308	420
275	375

Beach Flag Base



Ground-Drill

EN

- Stainless steel, plastic (1)
- Rotator included (2)

DE

- Rostfreier Stahl, Kunststoff (1)
- Inklusive rotierendem Gelenk (2)

NL

- Roestvast staal, kunststof (1)
- Inclusief rotator (2)

FR

- Acier inoxydable, plastique (1)
- Rotateur inclus (2)

ES

- Acero inoxidable, plástico (1)
- Rotador incluido (2)

Art. nr.	Product
BF-GD	Ground-Drill



Instructional video



Cross-Base

EN

- Black powder coated steel, rotator included
- Water bag (12 liter) (1)
- Sand bag (15 kg) (2)

DE

- Schwarzer pulverbeschichteter Stahl, inklusive rotierendem Gelenk
- Wassersack (12 Liter) (1)
- Sandsack (15 kg) (2)

NL

- Zwart gepoedercoat staal, inclusief rotator
- Waterzak (12 liter) (1)
- Zandzak (15 kg) (2)

FR

- Acier recouvert de poudre noire, rotateur inclus
- Sac à eau (12 litres) (1)
- Sac de sable (15 kg) (2)

ES

- Acero lacado en negro mate, rotador incluido
- Bolsa de agua (12 litros) (1)
- Bolsa de arena (15 kg) (2)



Instructional video

Art. nr.	Product	Profile width
BF-CB30	Cross-Base 30	30 mm
BF-CB50	Cross-Base 50	50 mm
BF-WB	Water Bag	
BF-SB	Sand Bag	

1: Optional

2: Optional

Ground-Pin

EN

- Massive galvanised steel (1)
- Rotator included, perfectly suitable at very strong wind (2)

DE

- Massiver verzinkter Stahl (1)
- inklusive rotierendem Gelenk, gut geeignet bei starkem Wind (2)

NL

- Roestvat staal, kunststof (1)
- Inclusief rotator (2)

FR

- Acier inoxydable, plastique (1)
- Rotateur inclus (2)

ES

- Acero macizo galvanizado (1)
- Rotador incluido, ideal en caso de vientos fuertes (2)

Ground-Pin 60

Ground-Pin 80

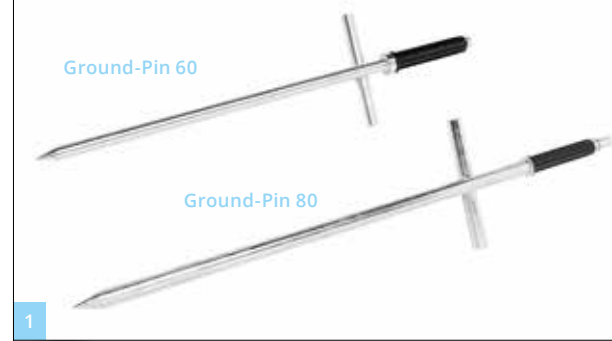

Art. nr.	Product	Length	Diameter
BF-GP60	Ground-Pin 60	60	1,6
BF-GP80	Ground-Pin 80	80	2,0

All sizes in cm.



Instructional video



Car-Foot

EN

- Chromed rotator and hex key included (1)

DE

- Verchromtes rotierendes Gelenk und Sechskantschlüssel inklusive (1)

NL

- Inclusief verchromde rotator en inbussleutel (1)

FR

- Rotateur chromé et clé Allen inclus (1)

ES

- Rotador y llave hexagonal incluidos (1)

Art. nr.	Product
BF-CF	Car-Foot



Instructional video



Beach Flag Base

Luxurious Steel Plate

6 / 12 / 20 KG

 400 x 400 x 5 mm

 550 x 550 x 5 mm

 550 x 550 x 8 mm



EN

- Black powder coated steel
- Equipped with 4 rubber feet (1)
- Chromed rotator and hex key included (2)
- **Optional:** Bag for steel plate (3)

DE

- Schwarzer pulverbeschichteter Stahl
- Ausgestattet mit 4 Gummifüßen (1)
- Verchromtes rotierendes Gelenk und Sechskantschlüssel inklusive (2)
- **Optional:** Tasche für Stahlplatte (3)



Instructional video

NL

- Zwart gepoedercoat staal
- Voorzien van 4 rubberen voetjes (1)
- Inclusief verchromde rotator en inbusleutel (2)
- **Optioneel:** Tas voor staalplaat (3)

FR

- Acier recouvert de poudre noire
- Equipé de 4 pieds en caoutchouc (1)
- Rotateur chromé, clé Allen inclus (2)
- **Optionnel :** Sac pour plaque en acier (3)

ES

- Acero lacado en negro mate
- Equipado de 4 patas de goma (1)
- Dispositivo de rotación y llave hexagonal incluidos (2)
- **Opcional:** Bolsa para base de acero (3)

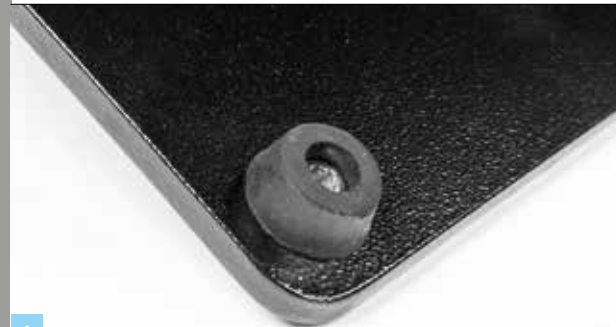

1



3: Optional



2

Art. nr.

BF-ST6
BF-ST12
BF-ST20

Product

Steel Plate 6 kg
Steel Plate 12 kg
Steel Plate 20 kg

BF-ST6BAG
BF-ST12.20BAG

Steel Plate 6 kg bag
Steel Plate 12 / 20 kg bag

Water Tank

EN

- Chromed rotator included (1)
- Carrying grip (2)
- Transportation wheels (3)

DE

- Verchromtes rotierendes Gelenk inklusive (1)
- Tragegriff (2)
- Transporträder (3)

NL

- Inclusief verchromde rotator (1)
- Handvat (2)
- Transportwielen (3)

FR

- Rotateur chromé inclus (1)
- Poignée de transport (2)
- Roues de transport (3)

ES

- Rotador cromado incluido (1)
- Asa de transporte (2)
- Ruedas de transporte (3)



Art. nr.

BF-WT24
BF-WT34

Product

Water Tank 24 liter
Water Tank 34 liter



Instructional video

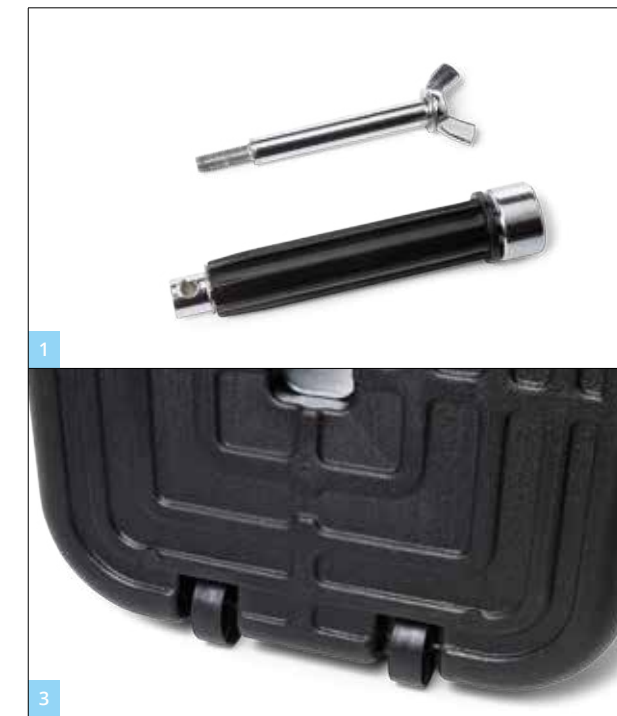

1



2

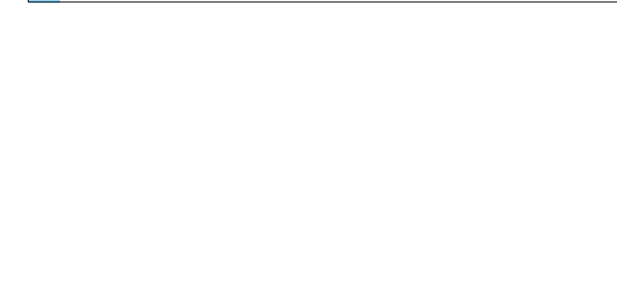

3

Promo Flag Wind & Drop



- ✓ One system for two shapes
- ✓ Steel flag base included

156



Instructional video



Promo Flag Wind & Drop

EN

- Fiberglass top (1)
- Fiberglass tubes diameter 20 mm, wall thickness 1,7 mm, aluminium reinforcement diameter 22,6 mm
- Base plate rotator included (2)
- Hook for attachment of flag (3)
- Bag with separated compartment for base plate and flag (4)

DE

- Glasfiberspitze (1)
- Fiberglas-Rohrdurchmesser 20 mm, Wandstärke 1,7 mm, Aluminiumverstärkung Durchmesser 22,6 mm
- Stahlplatte und Rotator inklusive (2)
- Haken zum Befestigen der Fahne (3)
- Tasche mit separaten Fächern für die Stahlplatte und Fahne (4)

NL

- Fiberglas bovenspriet (1)
- Fiberglas buisdiameter 20 mm, wanddikte 1,7 mm, aluminium versterking diameter 22,6 mm
- Inclusief voetplaat met rotator (2)
- Haak voor bevestiging vlag (3)
- Inclusief compacte tas met apart vak voor voet en print (4)

FR

- Tige supérieur en fibre de verre (1)
- Tubes de fibre de 20 mm de diamètre, épaisseur du tube 1,7 mm, avec renforcement aluminium 22,6 mm de diamètre
- Platine et rotateur inclus (2)
- Crochet pour l'attache de la voile (3)
- Sac avec compartiment séparés pour la platine et la voile (4)

ES

- Pieza superior del mástil de fibra de vidrio (1)
- Tubos de fibra de vidrio de 20 mm, grueso del tubo 1,7 mm, con refuerzo de aluminio 22,6 mm de diámetro
- Platina y rotador incluido (2)
- Gancho para fijar la bandera (3)
- Bolsa de transporte con compartimento separado para la platina y la bandera (4)

Product specifications

Art. nr.

PROFLAG

All sizes in cm.

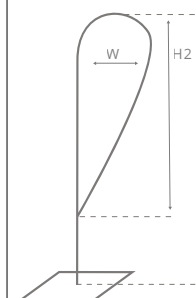

DROP SHAPE

W	H2	H1
45	150	196

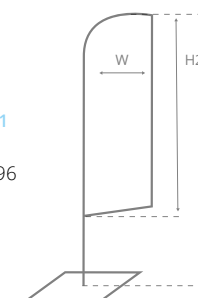

WIND SHAPE

W	H2	H1
40	162	205

Product specifications

Outer box

PCS	W	H	D
10	120	29	11

Pallet capacity

Euro	Industrial
240	300

No minimum order quantity.

Flag Pole 415

Large flag system

Stable base



1



2



3



4

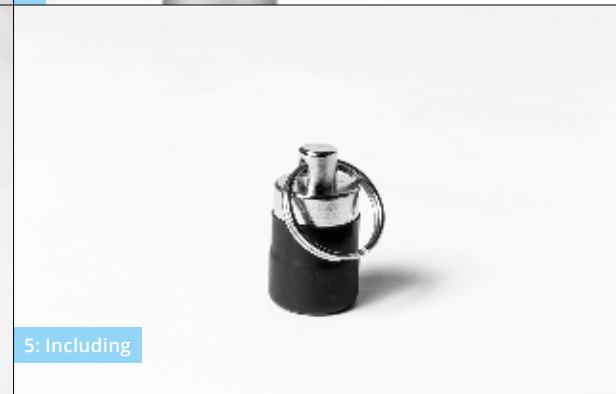

5: Including



Instructional video



Flag Pole 415

EN

- 50 liter water tank
- Aluminium tripod base (1)
- Completely screwed connections
- Clamp ring for extra fixation (2)
- Reinforced flag holder (3)
- 2 padded bags with zipper (4)
- Extra weight for down force flag (5)

DE

- 50 Liter Wassertank
- 3 Aluminiumstützmaste (1)
- Komplett verschraubte Verbindungen
- Klemmring zur Extrasicherung (2)
- Verstärkte Fahnenmaste (3)
- 2 Taschen mit Innenfutter und Reißverschluss (4)
- Zusatzgewicht zum Straffhalten der Fahne (5)

NL

- 50 liter watertank
- 3 aluminium mastschoren (1)
- Compleet geschroefde verbindingen
- Klemring voor extra fixatie (2)
- Verstevigde banieruithouder (3)
- 2 tassen met binnenvoering en ritssluiting (4)
- Extra gewicht om vlag strak te houden (5)

FR

- Réservoir à eau de 50 litres
- Base tripode en aluminium (1)
- Charnières complètement vissées
- Anneau resserable pour assurer une fixation résistante (2)
- Porte drapeau renforcé (3)
- 2 sacs renforcés avec fermeture éclair (4)
- Poids supplémentaire afin de renforcer la force d'appui du drapeau (5)

ES

- Tanque de agua de 50 litros
- Base de trípode de aluminio (1)
- Uniones completamente roscadas
- Anillo de sujeción para fijación extra (2)
- Soporte de bandera reforzado (3)
- 2 bolsas acolchadas con cremallera (4)
- Contrapeso inferior para tensar la bandera (5)

Product specifications

Art. nr.	Base
FP415	Ø 62

All sizes in cm.

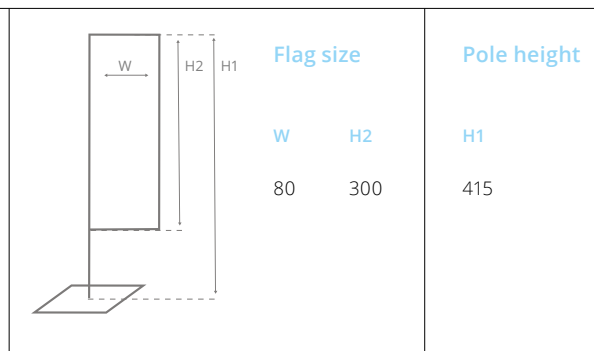

Flag size	
W	H2
80	300

Pole height
H1
415

Package specifications

Package	Tank				Pallet capacity	
	W	H	D	KG	Euro	Industrial
Tank	70	30	64	7	9	12
Pole	13	156	13	5,5		

Flag Pole 540

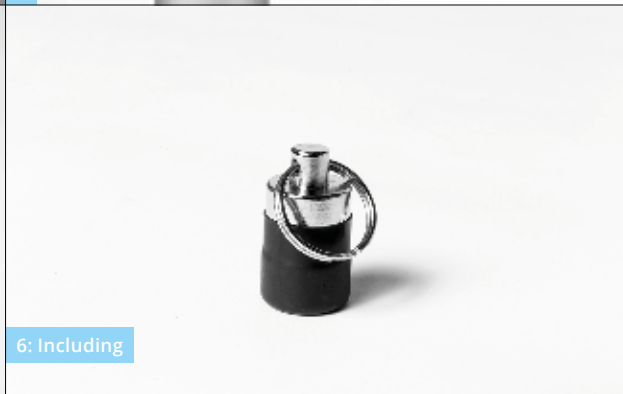

- Extremely large flag system
- Stable two-part base

160

Flag Pole 540

EN

- Aluminium 4 legged base (1)
- 2 x 40 liter water tank (2)
- Screwed connections
- Clamp ring for extra fixation (3)
- Reinforced flag holder (4)
- 2 padded bags with zipper (5)
- Extra weight for down force flag (6)

DE

- 4 Aluminiumstützmaste (1)
- 2 x 40 Liter-Wassertank (2)
- Verschraubte Verbindungen
- Klemmring zur Extrasicherung (3)
- Verstärkte Fahnenmaste (4)
- 2 Taschen mit Innenfutter und Reißverschluss (5)
- Zusatzgewicht zum straffhalten der Fahne (6)

NL

- 4 aluminium mastschoren (1)
- 2 x 40 liter watertank (2)
- Geschroefde verbindingen
- Klemring voor extra fixatie (3)
- Verstevigde banieruithouder (4)
- 2 tassen met binnenvoering en ritssluiting (5)
- Extra gewicht om vlag strak te houden (6)

FR

- Base 4 points en aluminium (1)
- 2 x réservoirs à eau de 40 litres (2)
- Charnières vissées
- Anneau resserable pour assurer une fixation résistante (3v)
- Porte drapeau renforcé (4)
- 2 sacs renforcés avec fermeture éclair (5)
- Poids supplémentaire afin de renforcer la force d'appui du drapeau (6)

ES

- Base de aluminio con 4 patas de aluminio (1)
- 2 x tanque de agua de 40 litros (2)
- Terminales de rosca
- Anillo de sujeción para fijación extra (3)
- Soporte de bandera reforzado (4)
- 2 bolsas acolchadas con cremallera (5)
- Contrapeso inferior para tensar la bandera (6)



Instructional video

Product specifications

Art. nr.	Base
FP540	80 x 80

All sizes in cm.

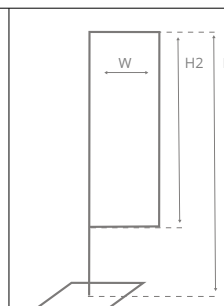

Flag size	Pole height	
	W	H2
	110	330
	H1: 540	

Package specifications

Package	Pallet capacity			
	W	H	D	KG
Tank	80	38	43	10
Pole	15	160	13	6,5
	Euro	Industrial		
	10	10		

Cases

Hard Case	166
Trolley Case	167
Transport Trolley	168
Soft Trolley	169

Case

Hard Case

Used for our Pop-Up Magnetic



Front side

Backside



1



2

EN

- Extremely solid hard case with strong twist hinges and a carrying grip on the side
- Heavy duty wheels (1)
- Padded bag and firm divider to protect the print (2)

DE

- Äußerst solider Transportkoffer mit robusten Drehscharnieren und Tragegriff an der Seite
- Massive starke Transporträder (1)
- Tasche mit Innenfutter und Mittelabtrennung zum Schutz der Drucke (2)

NL

- Extreem solide transportkoffer met sterke draaischarnieren en een draaghandvat aan de zijkant
- Massieve sterke wielen (1)
- Gevoerde zak en stevig scheidingspaneel voor bescherming print (2)

FR

- Valise de transport extrêmement solide avec charnières pivotantes résistantes et une poignée sur le côté
- Roues hautement résistantes (1)
- Sac rembourré et séparateur fixe permettant de protéger les visuels imprimés (2)

ES

- Trolley de transporte muy resistente con bisagras resistentes y un asa lateral
- Ruedas altamente resistentes (1)
- Bolsa acolchada con separador sólido para proteger la impresión (2)

Product specifications

Art. nr.	Inner size		
	W	H	D
PUHCL	65	80	35

All sizes in cm.

Package specifications

PCS	Outer box				KG
	W	H	D		
1	71	100	41	14	

No minimum order quantity.



Instructional video

Case

Trolley Case

Used for our Pop-Up Fabric



Trolley case medium (M)

Trolley case large (L)

Trolley case extra large (XL)



1



2

Case Trolley Case

EN

- Wide wheel base with ball bearing wheels (1)
- Solid trolley case with extendible handle (2)

DE

- Breiter Radstand mit kugelgelagerten Rädern (1)
- Trolley mit ausziehbarem Griff (2)

NL

- Brede wielbasis met kogelgelagerde wielen (1)
- Solide transportkoffer met uitschuifbare handgreep (2)

FR

- Position large dos roues avec roulement à billes (1)
- Poignée de valise télescopique (2)

ES

- Ancho de rueda con rodamientos de bolas (1)
- Asa de trolley extensible (2)

Product specifications

Art. nr.	Size	Inner size		
		W	H	D
PUTCM	M	33	85	30
PUTCL	L	43	85	30
PUTCXL	XL	53	85	30

All sizes in cm.

Package specifications

PCS	Outer box				KG
	W	H	D		
1	39	98	39	5	
1	48	98	39	5,5	
1	56	98	39	6	

No minimum order quantity.



Instructional video

Case Transport Trolley

Used for our Zipper-Walls



Transport trolley medium (M)

Transport trolley large (L)

Transport trolley extra large (XL)



1



2

Case **Transport Trolley**

EN

- Reinforced transport trolley for durable professional use (1)
- Solid wheel base with ball bearing wheels (2)

DE

- Verstärkter Transporttrolley für Langzeitgebrauch (1)
- Solide Radbasis mit kugelgelagerten Rädern (2)

NL

- Verstevigde transporttrolley voor langdurig professioneel gebruik (1)
- Solide wielbasis met kogelgelagerde wielen (2)

FR

- Valise de transport robuste pour une utilisation professionnelle durable (1)
- Roues solides avec roulement à billes (2)

ES

- Trolley profesional reforzado para transporte y uso duradero (1)
- Ase sólida con ruedas con rodamientos de bolas (2)

Product specifications

Art. nr.	Size	Inner size		
		W	H	D
TT120M	M	25	12	119
TT120L	L	25	17	119
TT120XL	XL	25	22	119

All sizes in cm.

Package specifications

PCS	Outer box				KG
	W	H	D		
1	33	132	19		5
1	33	132	23		5,7
1	33	132	28		6,4

No minimum order quantity.



Instructional video

Case Soft Trolley

Used for our Counter Fabric



Max. load: 15 KG



1



2

Case **Soft Trolley**

EN

- Wide wheel base with ball bearing wheels (1)
- Extendible trolley handle (2)

DE

- Breiter Radstand mit kugelgelagerten Rädern (1)
- Trolley mit ausziehbarem Griff (2)

NL

- Brede wielbasis met kogelgelagerde wielen (1)
- Uitschuifbare trolley handgreep (2)

FR

- Roues situées de chaque côtés dotées de roulement à billes (1)
- Poignée de valise télescopique (2)

ES

- Ancho de rueda con rodamientos de bolas (1)
- Asa de trolley extensible (2)

Product specifications

Art. nr.	Inner size		
	W	H	D
ST	40	23	108

All sizes in cm.

Package specifications

PCS	Outer box				KG
	W	H	D		
1	46	117	27		6,7

No minimum order quantity.



Instructional video



Context Type & Sign Pink GmbH

Klagenfurter Straße 156, 9300 St.Veit/Glan, Austria, Tel.: +43 4212 2024, Fax: +43 4212 2024 18
office@context-online.at, www.context-online.at